



KEY to productivity

VTL Series

You Ji Machine Industrial Company Limited
CNC Vertical Turning Center



No.92, Huanqiu Rd., Zhuyuan Vil.,
Luzhu Dist., Kaohsiung City 82142, Taiwan
Tel: 886-7-695-2669
Fax: 886-7-695-3301
Email : youji@ms15.hinet.net

Distributor

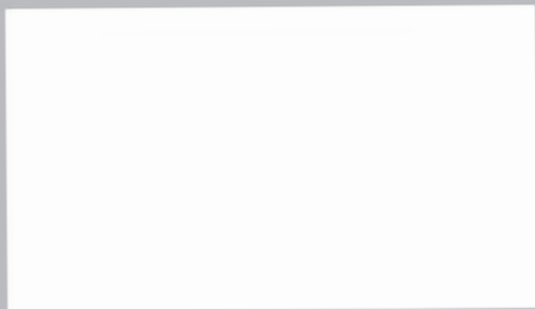

2018.06
A



VTL Series CNC Vertical Turning Center



▲ Double column vertical turning center



▲ VTL1200ATC+C vertical turning center



▲ Full enclosure guarding

You Ji Machine Industrial Company Limited

With over 40 years experience, You Ji has obtained customers' support in design and quality of machine. There are many machines to meet customers' different needs. Table diameter from Ø200 to Ø8000mm. You Ji is the first machine manufacturer to have passed CE and EMC and to have begun sales in the European market, and is the biggest vertical lathe and floor borer manufacturer in Taiwan. The cooperation between You Ji and other advanced machine manufacturers helps to upgrade the quality of You Ji products and provide customers the best and fastest service in the business.

Machine Features

VTL1600ATC+C-I-2R-APC

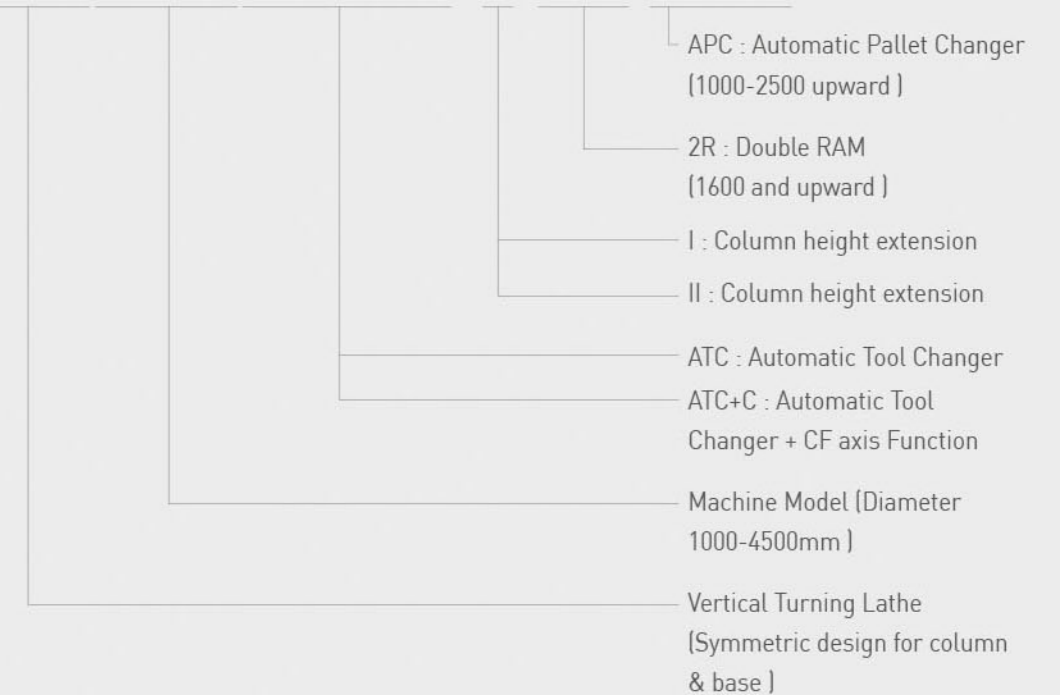

High Rigidity Structure

- VTL superior structure with symmetrical column design and increased thickness, provides 50% more rigidity for outstanding cutting performance.
- Distance between centerline of Z axis to surface of cross rail is shortened to increase machining stability.



Superior rigid machine base



The stability can be maintained with shortening torque design.

Thickness increased to guarantee structural rigidity.

ONE Piece Column(VTL1000-2500)

- The machine column and base are manufactured from Meehanite castings, received a full heat treatment and full a stress-relieved process. This design and manufacturing process gives the best rigidity and ensures high machine stability.
- The heavily walled and multi ribbed design minimizes the thermal distortion, withstanding static and dynamic torsion, ensures a high rigid and stable machine assembly.

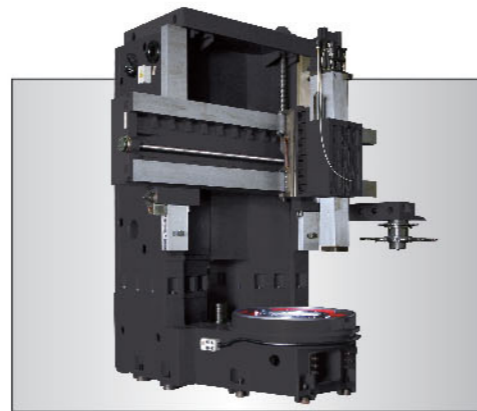

Double Column Structure(VTL3000-4500)

- The MEEHANITE casting bed and double column design provide solid support and anti-vibration solution to ensure ultimate dynamic accuracy and stability.
- Wide span column structure provides optimal column rigidity and stability. The wide span design retains stability and machining accuracy and increase the effective machining range.



High stability architecture

Machine Base and Column

The high rigidity box type symmetric column structure is fitted to machine base. The heavily walled and multi ribbed design minimizes the thermal distortion, withstanding static and dynamic torsion, ensures a high rigid and stable machine assembly.

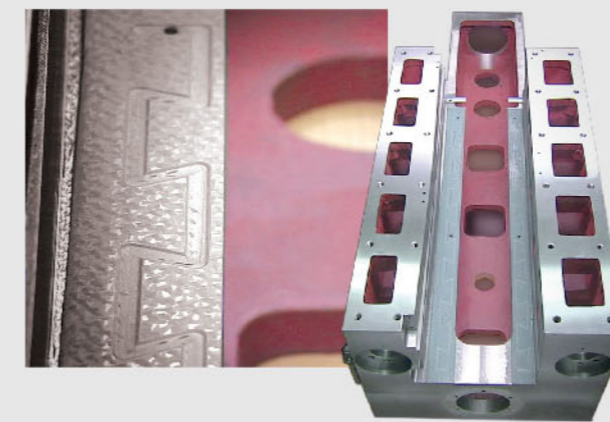
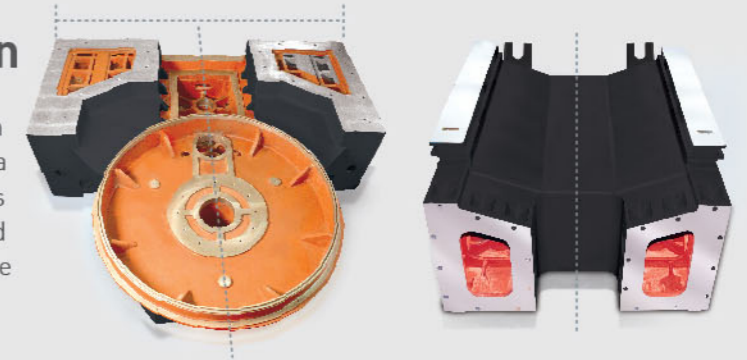

Box slideways structure

Z axis box guide way is induction hardened and precision ground, the mating sliding faces are Turcite B coated allowing slide assemblies to move with ease and low friction.

X&Z Axes Box Guideways

- The X and Z axes box guideways are induction hardened and precision ground, the mating sliding faces are Turcite-B coated allowing slide assemblies to move with ease and low friction.
- The slideway lubrication is controlled by an automatic central lube feeding system. The volume and timing of lubrication is controlled by CNC and enhances the machine accuracy and life.

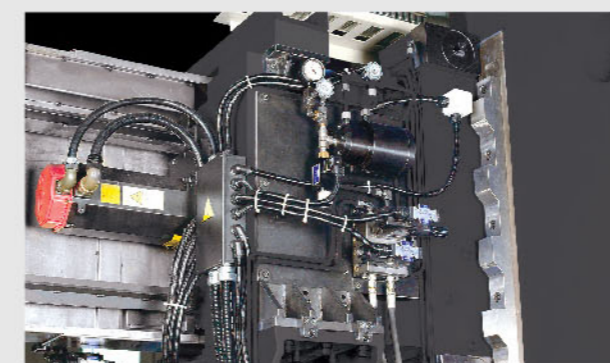
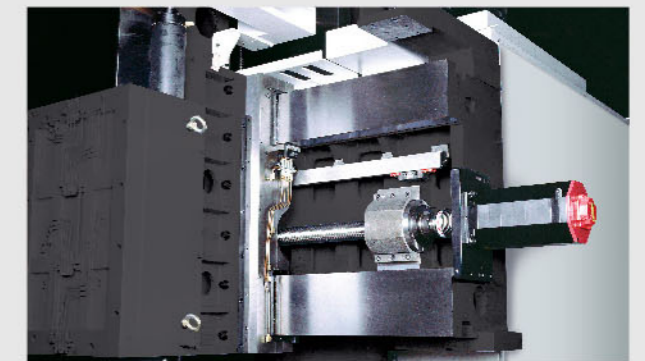

Cross-rail

The cross-rail can move up and down in steps of every 200 mm which is designed for accommodating different height of workpieces. Cross-rail movement can be commanded via M-code, and positioned with 4 hydraulic cylinders. Sturdy and precise clamping leads to excellent machining results.

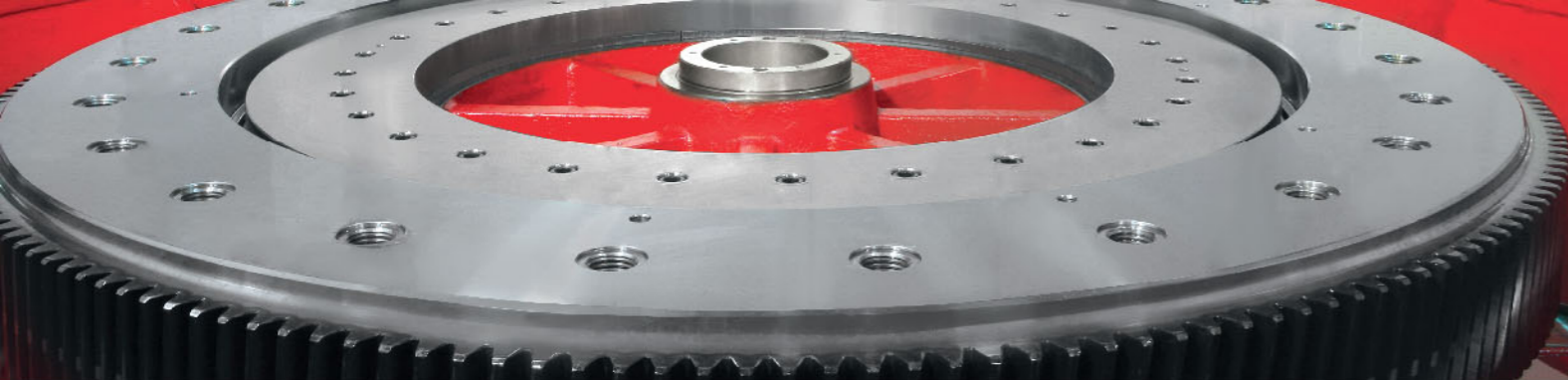

High Efficiency Transmission

High precision spindle

Cross roller bearing (standard)

- Distance of working point is increased with excellent spindle supporting force to bear the loads and moments in all directions for longer heavy cutting.
- The spindle structure is designed to optimize heat dissipation to effectively controlling thermal deformation, provides high accuracy and excellent reliability for longer bearing life.
- Nylon separators feature low inertia, ensuring the machine operation under low running torque, highlighted the lowest energy consumption.
- Two rows of rollers-cross roller bearing design consequently less bearing wear and heat generation, easy to control quality and manufacturing.

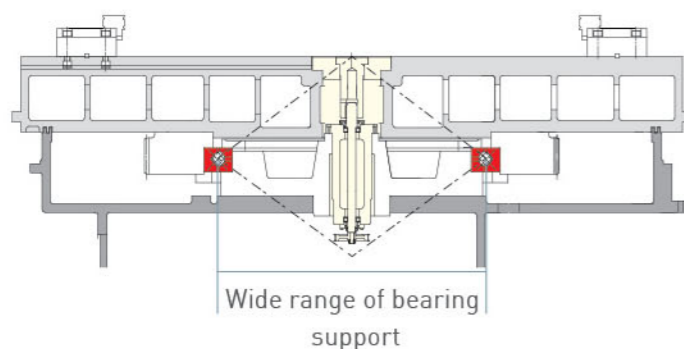

Radial load : ★★★★★ Load capacity : ★★★★★
 Axial load : ★★★★★ Service life : ★★★★★

High Precision Driven Gear

High grade nickel-chrome alloy steel is used for the driven gear. Correct heat treatment and accurate grinding allows it be classified as first class precision in the Japanese JIS 1 standards.



CF axis

VTL1000-2500ATC+C Series

High precision CF axis delivers extraordinary performance on positioning accuracy, integrating the live spindle to perform precise drilling, tapping, milling operations. Most operations can be done without resetting, therefore reduces non-cutting time and saves labor cost.



CS axis

VTL3000-4500ATC+C Series(VTL2000-2500ATC+C Series Option)

Special dual-drive spindle system with CS axis indexing mechanism enhances spindle output torque and eliminates mechanical transmission backlash, the repeatability of indexing accuracy of the CS axis is 5 seconds, positioning accuracy 10 seconds.

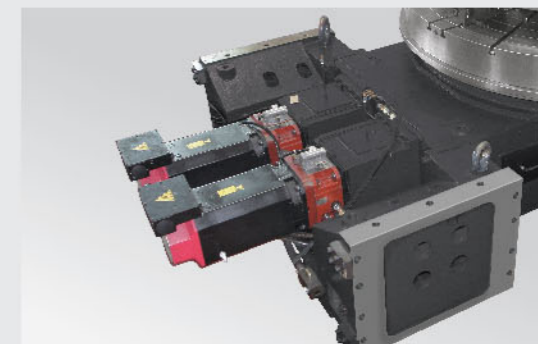

Z axis configuration

Z axis uses a high precision ball screw, and is driven directly by AC servo motor, the counterbalance cylinder system ensures high accuracy machining results. The perfectly balanced mass enhances the structural rigidity and reliability.

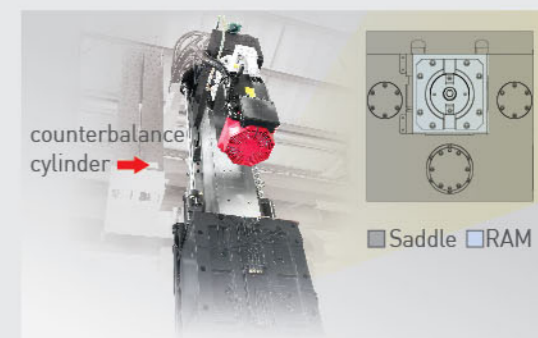

Z axis-Dual Servo Motor Driven RAM (option)

VTL2000-4500 Series

- The Z axis is driven by two servo motor and high precision ball screws. The robust structure leads to rigid cutting and precision performance that heavy duty cutting demands.
- The ram itself is a 280 mm square casting. The casted and hardened steel construction provides the stiffness for heavy duty operations, while permitting the turning of smaller bores, eliminating the added expense of boring bars in many instances
- Obviously enhancing curve profile machining accuracy, improve surface cutting performance and provides best cutting feedrate & cutting force.



Torque Chart (FANUC Spindle Motor)

----- 30 Min operation zone — Low gear
 — Continuous operation zone — High gear

1R series

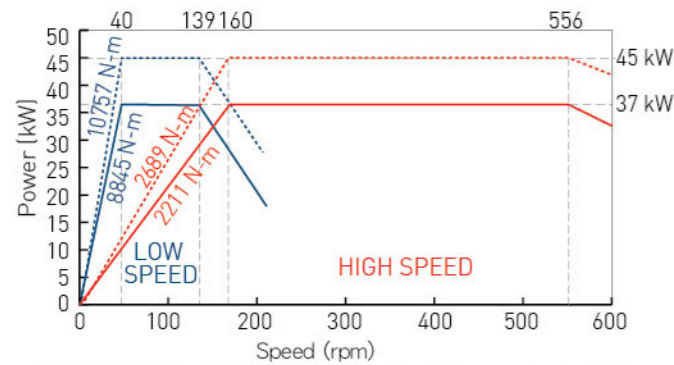

(MOTOR: FANUC α il40/7000) High speed ratio: 7.2 Low speed ratio: 28.8
VTL1000ATC Series

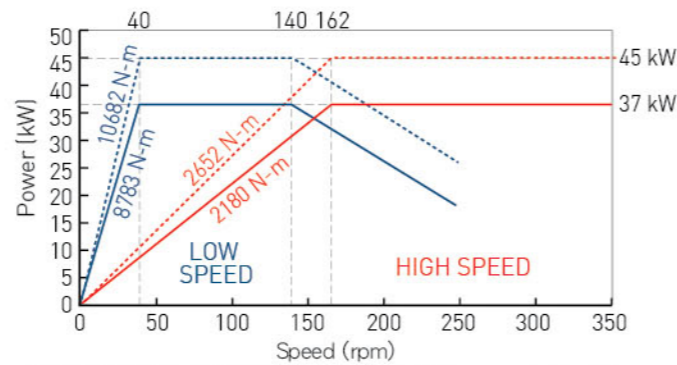

(MOTOR: FANUC α il40/7000) High speed ratio: 7.1 Low speed ratio: 28.6
VTL1200ATC Series

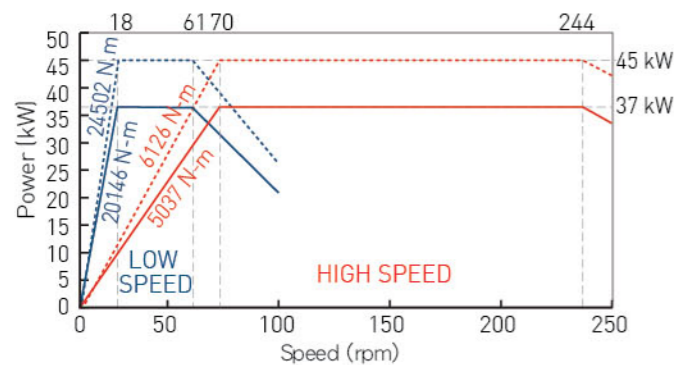

(MOTOR: FANUC α il40/7000) High speed ratio: 16.4 Low speed ratio: 65.6
VTL1600ATC Series

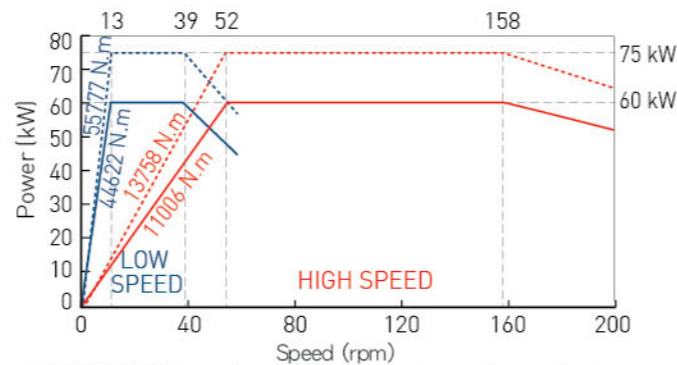

(MOTOR: FANUC α il60/5000HV) High speed ratio: 22.1 Low speed ratio: 89.6
VTL2000ATC Series

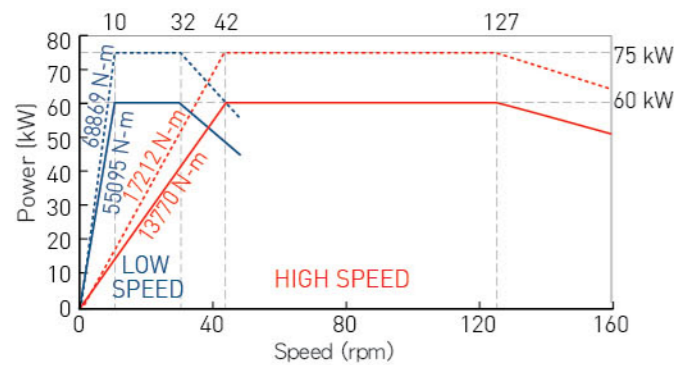

(MOTOR: FANUC α il60/5000HV) High speed ratio: 27.65 Low speed ratio: 110.63
VTL2500ATC Series

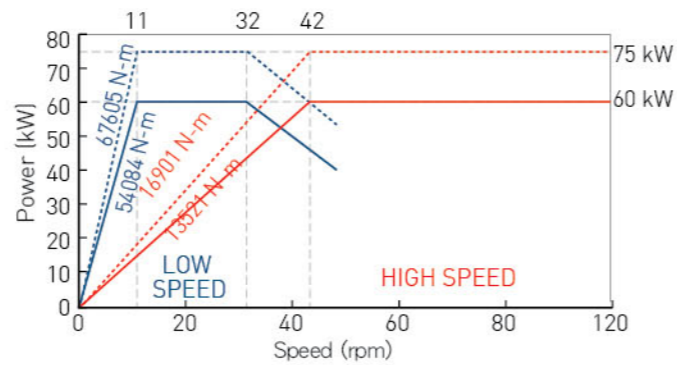

(MOTOR: FANUC α il60/5000HV) High speed ratio: 27.15 Low speed ratio: 108.60
VTL3000ATC Series

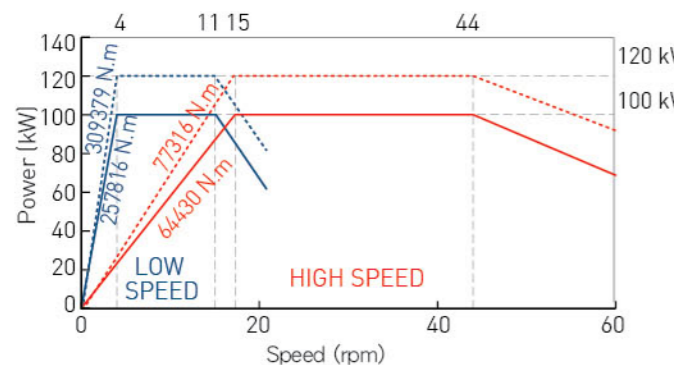

(MOTOR: FANUC α il100/5000HV) High speed ratio: 67.50 Low speed ratio: 270.10
VTL3500ATC Series

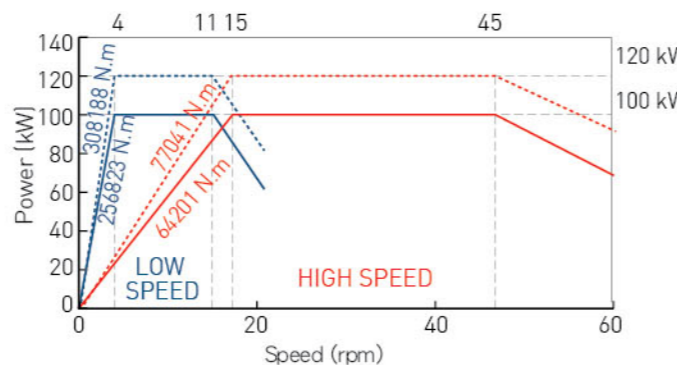

(MOTOR: FANUC α il100/5000HV) High speed ratio: 67.26 Low speed ratio: 269.06
VTL4000ATC/VTL4500ATC Series

1R+C series

----- 30 Min operation zone — Low gear
 — Continuous operation zone — High gear

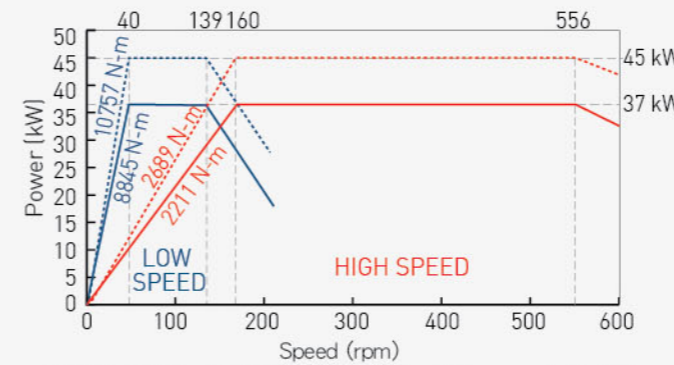

(MOTOR: FANUC α il40/7000) High speed ratio: 7.2 Low speed ratio: 28.8
VTL1000ATC+C Series

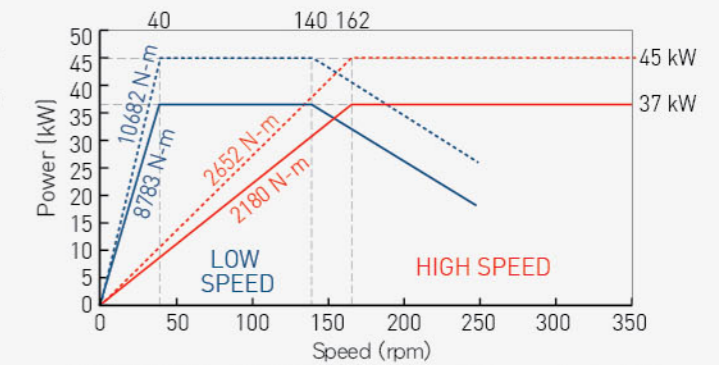

(MOTOR: FANUC α il40/7000) High speed ratio: 7.1 Low speed ratio: 28.6
VTL1200ATC+C Series

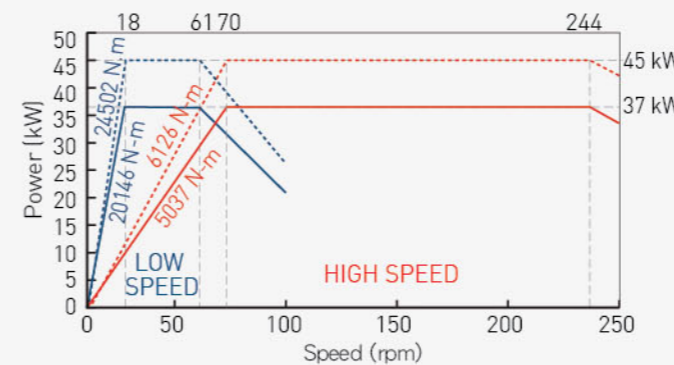

(MOTOR: FANUC α il40/7000) High speed ratio: 16.4 Low speed ratio: 65.6
VTL1600ATC+C Series

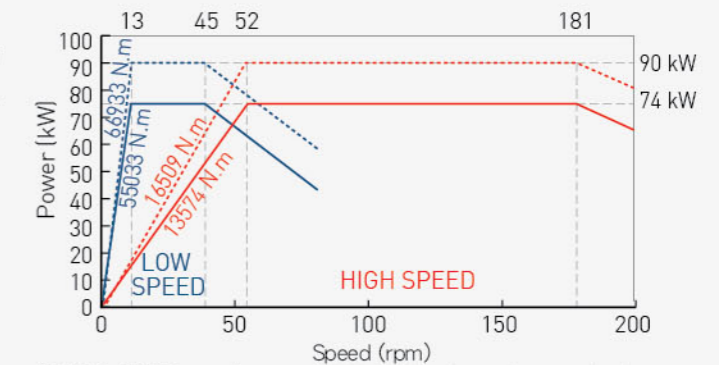

(MOTOR: FANUC α il40/7000HVx2) High speed ratio: 22.1 Low speed ratio: 89.6
VTL2000ATC+C Series (Opt.)

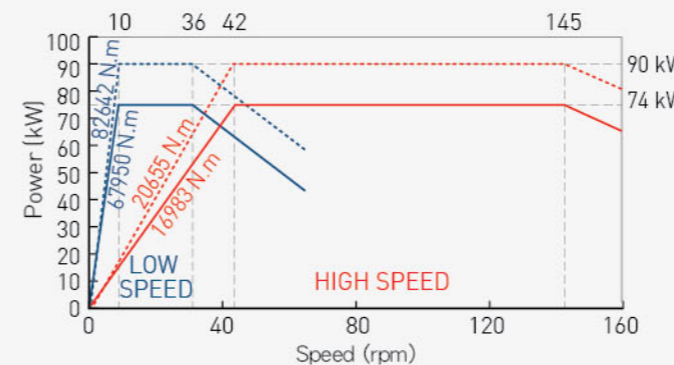

(MOTOR: FANUC α il40/7000HVx2) High speed ratio: 27.65 Low speed ratio: 110.63
VTL2500ATC+C Series (Opt.)

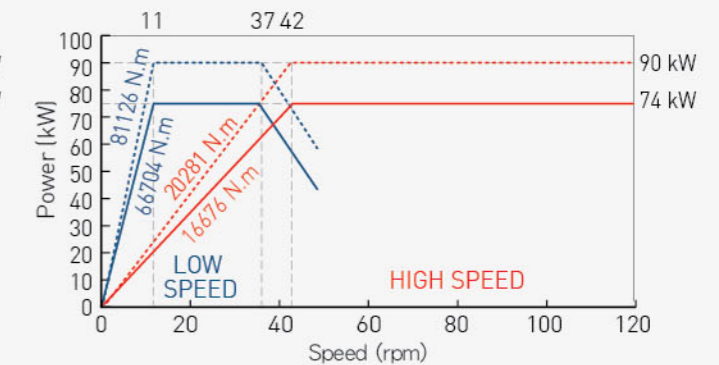

(MOTOR: FANUC α il40/7000HVx2) High speed ratio: 27.15 Low speed ratio: 108.60
VTL3000ATC+C Series

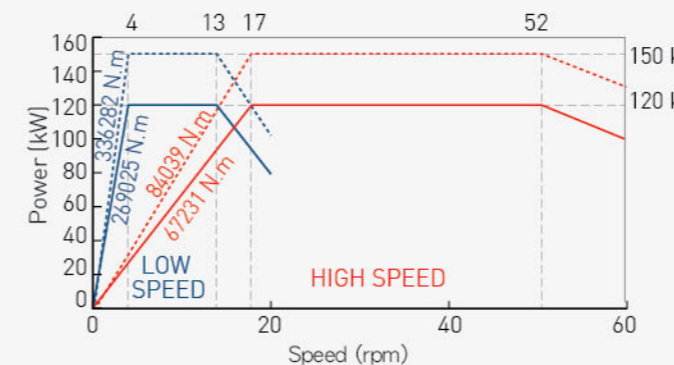

(MOTOR: FANUC α il60/5000HVx2) High speed ratio: 67.50 Low speed ratio: 270.10
VTL3500ATC+C Series

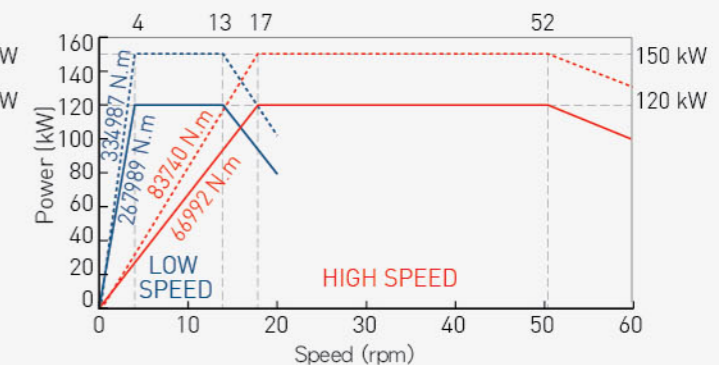

(MOTOR: FANUC α il60/5000HVx2) High speed ratio: 67.26 Low speed ratio: 269.06
VTL4000ATC+C/VTL4500ATC+C Series

Torque Chart (FANUC Spindle Motor)

2R series

..... 30 Min operation zone
 ——— Continuous operation zone
 ——— Low gear
 ——— High gear

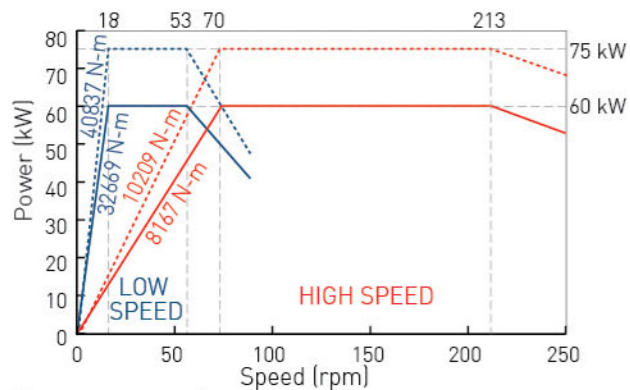

(MOTOR: FANUC α il60/5000HV) High speed ratio: 16.4 Low speed ratio: 65.6
 VTL1600ATC-2R Series

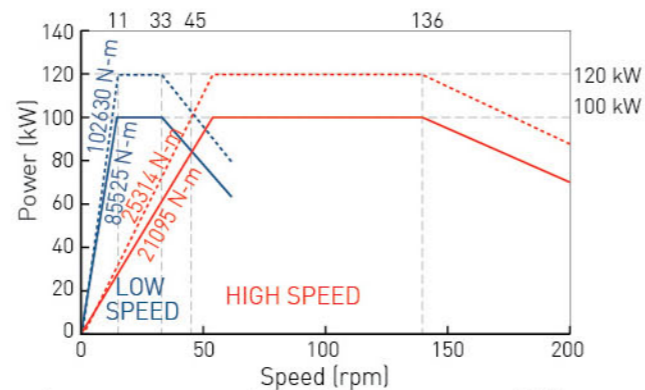

(MOTOR: FANUC α il100/5000HV) High speed ratio: 22.1 低速比: 89.6
 VTL2000ATC-2R Series

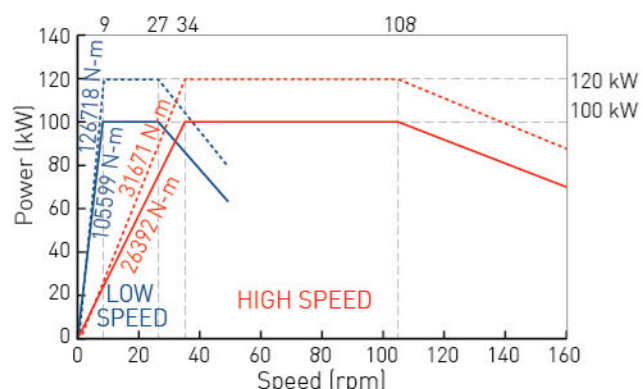

(MOTOR: FANUC α il100/5000HV) High speed ratio: 27.65 Low speed ratio: 110.63
 VTL2500ATC-2R Series

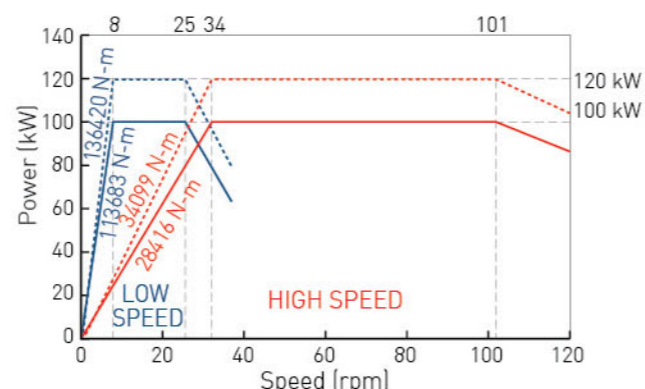

(MOTOR: FANUC α il100/5000HV) High speed ratio: 29.77 Low speed ratio: 119.10
 VTL3000ATC-2R Series

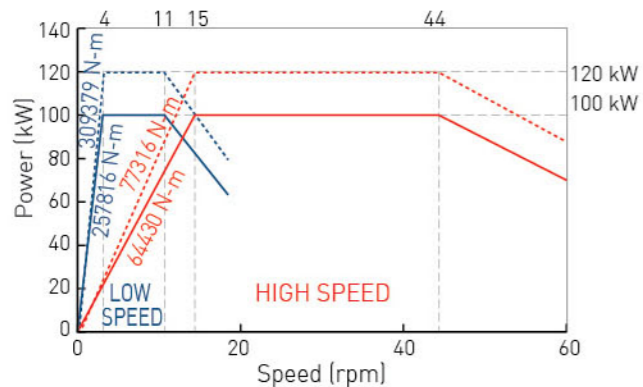

(MOTOR: FANUC α il100/5000HV) High speed ratio: 67.5 Low speed ratio: 270.1
 VTL3500ATC-2R Series

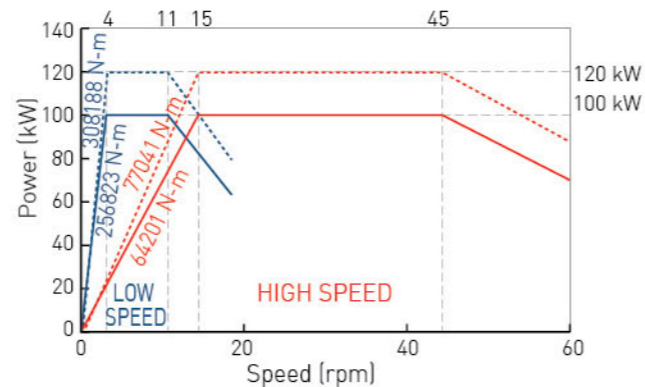

(MOTOR: FANUC α il100/5000HV) High speed ratio: 67.26 Low speed ratio: 269.06
 VTL4000ATC-2R/VTL4500ATC-2R Series

2R+C series

..... 30 Min operation zone
 ——— Continuous operation zone
 ——— Low gear
 ——— High gear

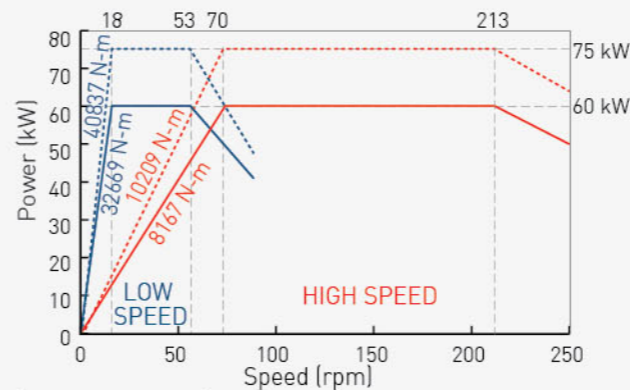

(MOTOR: FANUC α il60/5000HV) High speed ratio: 16.4 Low speed ratio: 65.6
 VTL1600ATC+C-2R Series

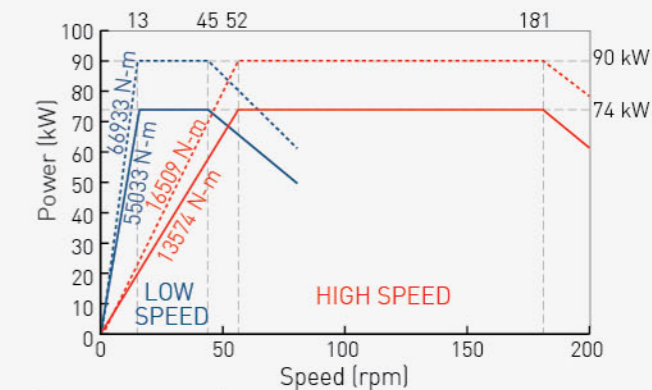

(MOTOR: FANUC α il40/7000HVx2) High speed ratio: 22.1 Low speed ratio: 89.6
 VTL2000ATC+C-2R Series

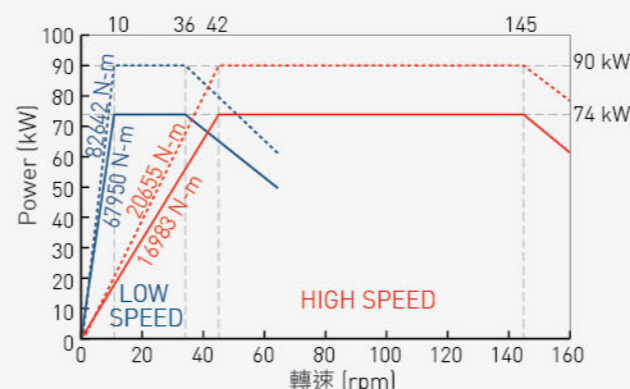

(MOTOR: FANUC α il40/7000HVx2) High speed ratio: 27.65 Low speed ratio: 110.63
 VTL2500ATC+C-2R Series

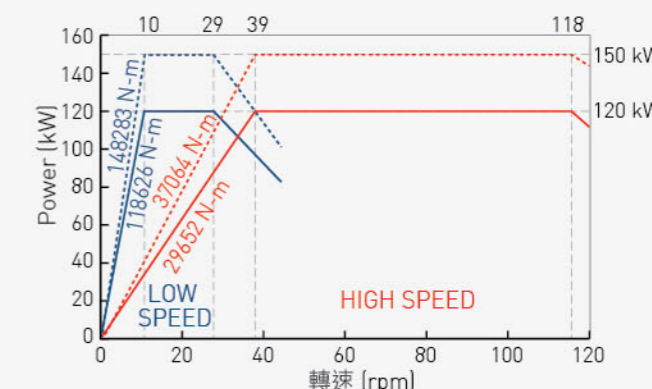

(MOTOR: FANUC α il60/5000HVx2) High speed ratio: 29.77 Low speed ratio: 119.10
 VTL3000ATC+C-2R Series

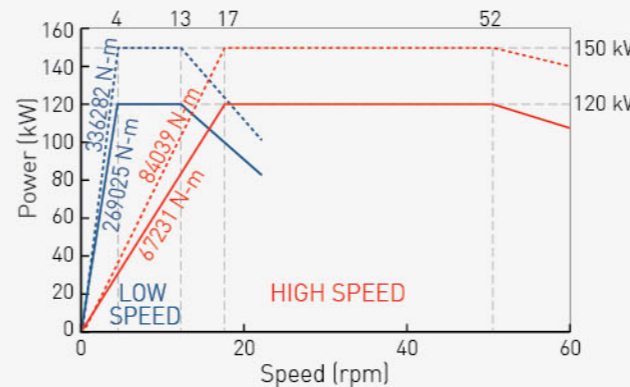

(MOTOR: FANUC α il60/5000HVx2) High speed ratio: 67.5 Low speed ratio: 270.1
 VTL3500ATC+C-2R Series

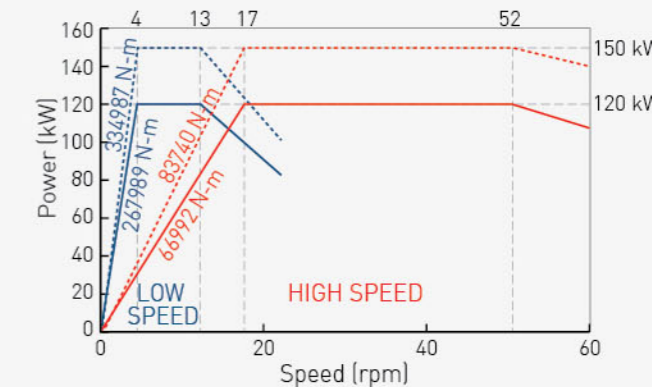

(MOTOR: FANUC α il60/5000HVx2) High speed ratio: 67.26 Low speed ratio: 269.06
 VTL4000ATC+C-2R/VTL4500ATC+C-2R Series

Torque Chart (SIEMENS Spindle Motor)

----- 30 Min operation zone
----- Continuous operation zone
— Low gear
— High gear

1R series

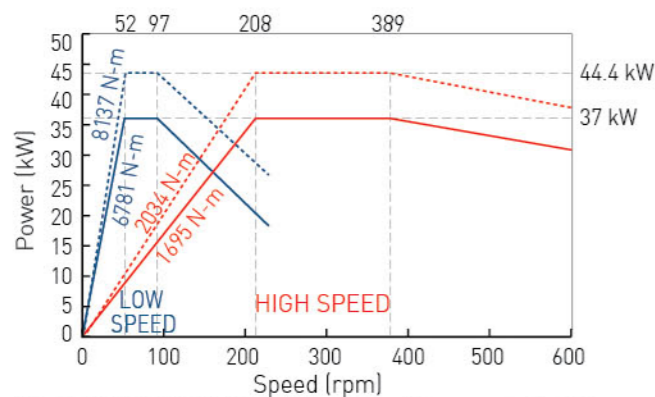

(MOTOR: SIEMENS 1PH8165-F) High speed ratio: 7.2 Low speed ratio: 28.8
VTL1000ATC Series

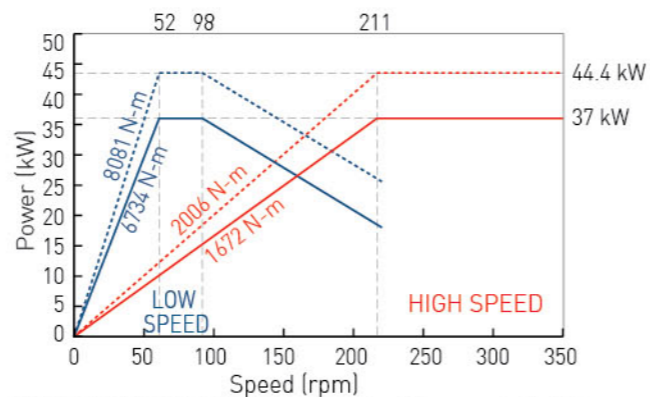

(MOTOR: SIEMENS 1PH8165-F) High speed ratio: 7.1 Low speed ratio: 28.6
VTL1200ATC Series

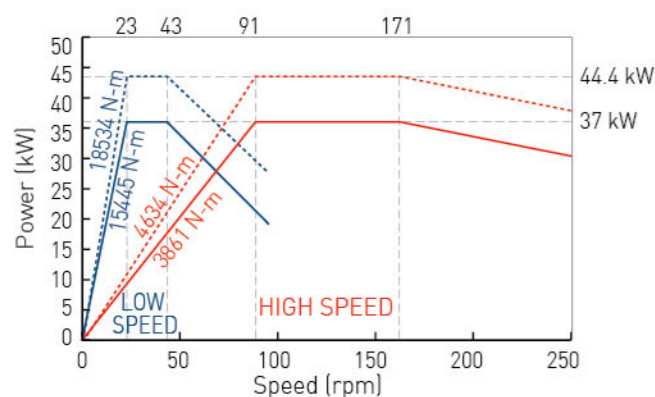

(MOTOR: SIEMENS 1PH8165-F) High speed ratio: 16.4 Low speed ratio: 65.6
VTL1600ATC Series

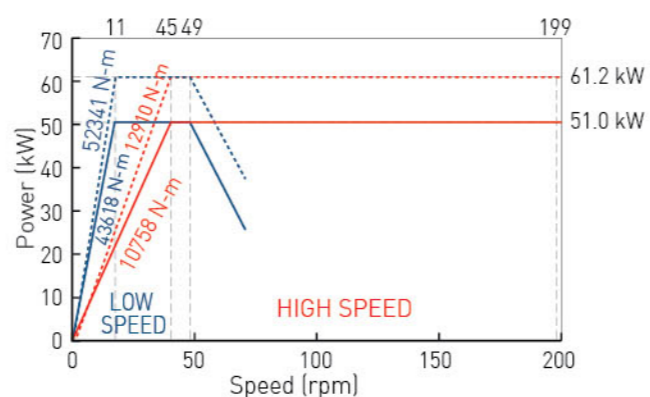

(MOTOR: SIEMENS 1PH8186-D) High speed ratio: 22.1 Low speed ratio: 89.6
VTL2000ATC Series

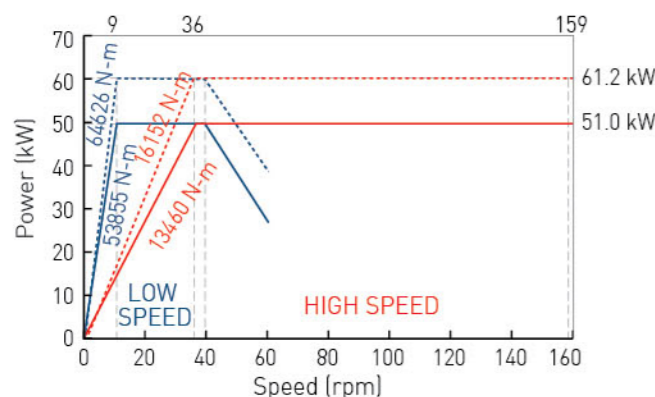

(MOTOR: SIEMENS 1PH8186-D) High speed ratio: 27.65 Low speed ratio: 110.63
VTL2500ATC Series

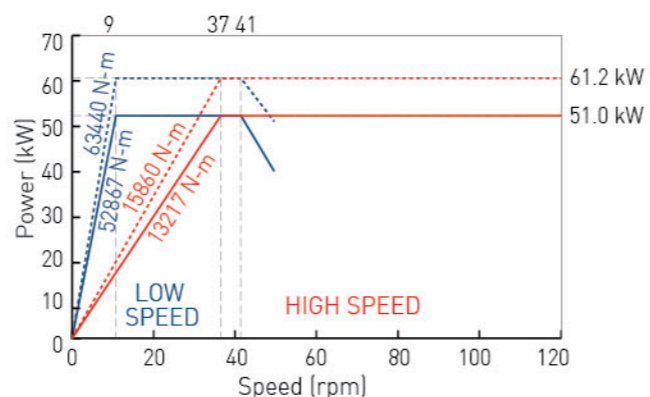

(MOTOR: SIEMENS 1PH8186-D) High speed ratio: 27.15 Low speed ratio: 108.6
VTL3000ATC Series

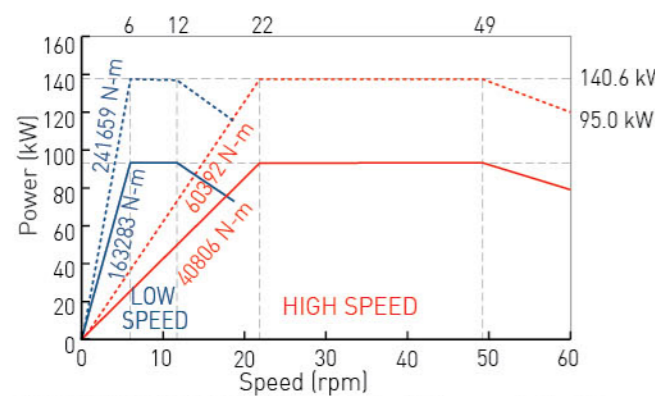

(MOTOR: SIEMENS 1PH8224-F) High speed ratio: 67.5 Low speed ratio: 270
VTL3500ATC Series

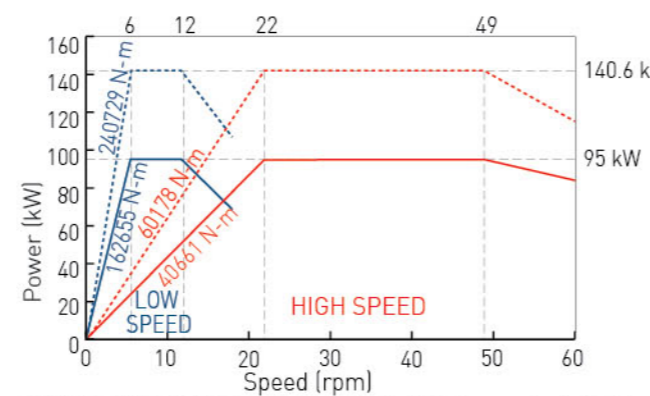

(MOTOR: SIEMENS 1PH8224-F) High speed ratio: 67.26 Low speed ratio: 269.06
VTL4000ATC/VTL4500ATC Series

1R+C series

----- 30 Min operation zone
----- Continuous operation zone
— Low gear
— High gear

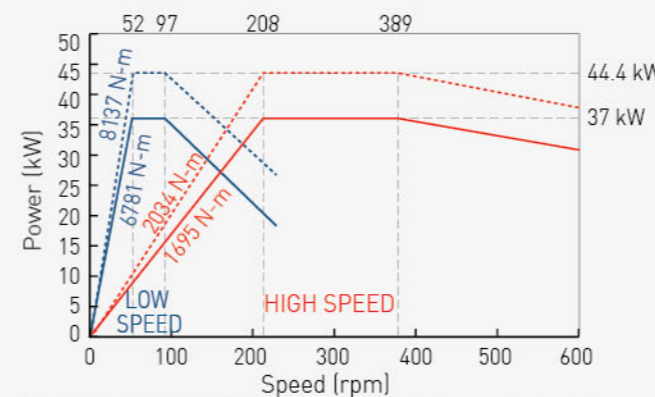

(MOTOR: SIEMENS 1PH8165-F) High speed ratio: 7.2 Low speed ratio: 28.8
VTL1000ATC+C Series

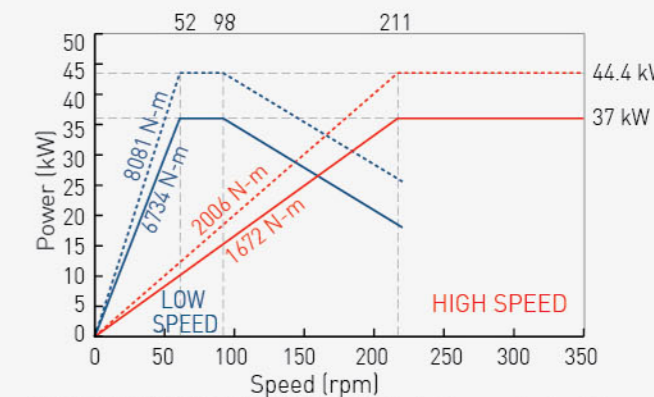

(MOTOR: SIEMENS 1PH8165-F) High speed ratio: 7.1 Low speed ratio: 28.6
VTL1200ATC+C Series

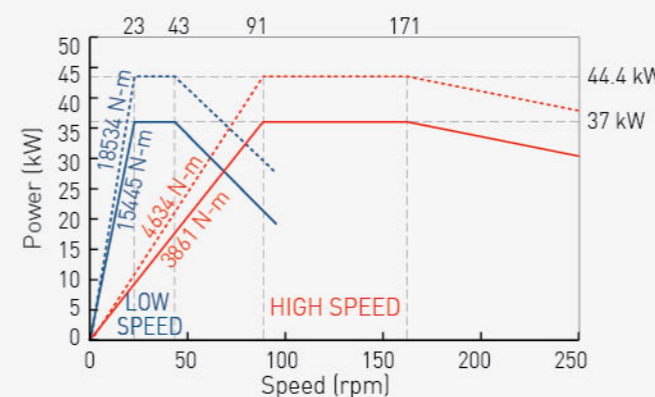

(MOTOR: SIEMENS 1PH8165-F) High speed ratio: 16.4 Low speed ratio: 65.6
VTL1600ATC+C Series

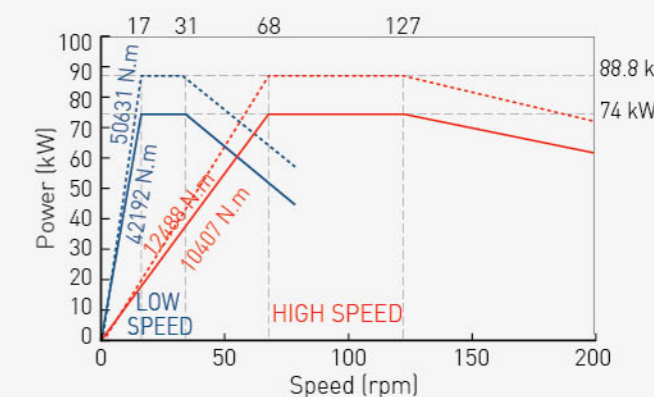

(MOTOR: SIEMENS 1PH8165-Fx2) High speed ratio: 22.1 Low speed ratio: 89.6
VTL2000ATC+C Series (Opt.)

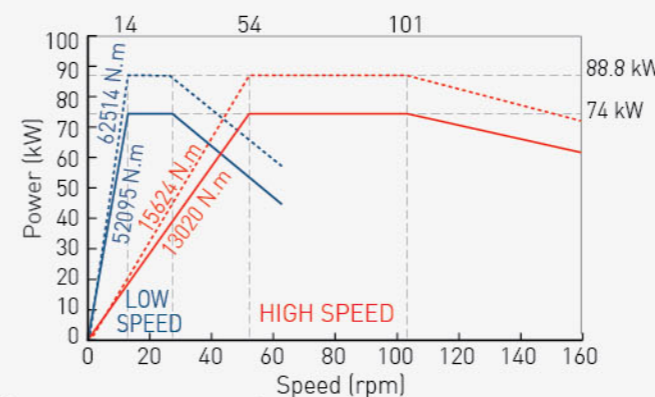

(MOTOR: SIEMENS 1PH8165-Fx2) High speed ratio: 27.65 Low speed ratio: 110.63
VTL2500ATC+C Series (Opt.)

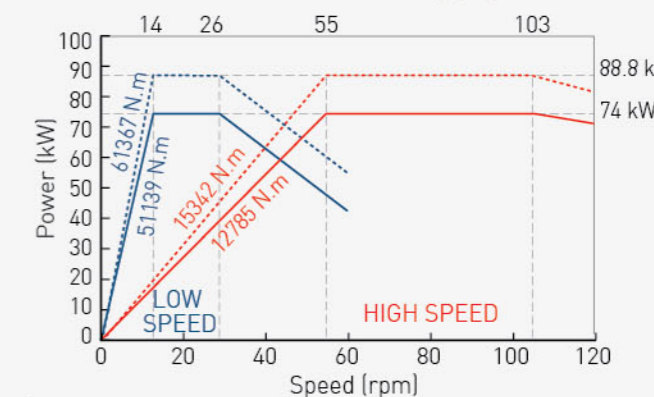

(MOTOR: SIEMENS 1PH8165-Fx2) High speed ratio: 27.15 Low speed ratio: 108.6
VTL3000ATC+C Series

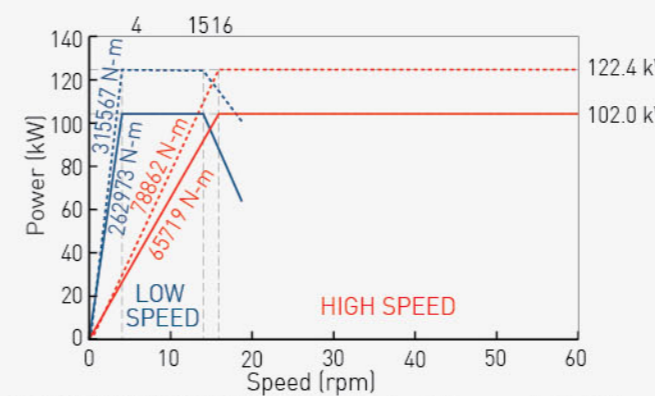

(MOTOR: SIEMENS 1PH8186-Dx2) High speed ratio: 67.5 Low speed ratio: 270.1
VTL3500ATC+C Series

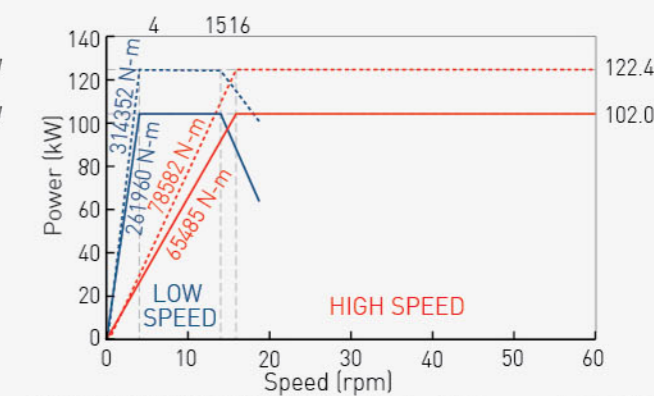

(MOTOR: SIEMENS 1PH8186-Dx2) High speed ratio: 67.26 Low speed ratio: 269.06
VTL4000ATC+C/VTL4500ATC+C Series

Torque Chart (SIEMENS Spindle Motor)

----- 30 Min operation zone
----- Continuous operation zone
— Low gear
— High gear

2R series

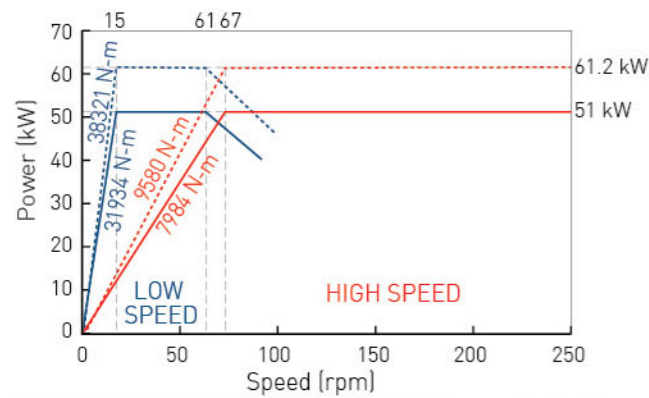

(MOTOR: SIEMENS 1PH8186-D) High speed ratio: 16.4 Low speed ratio: 65.6
VTL1600ATC-2R Series

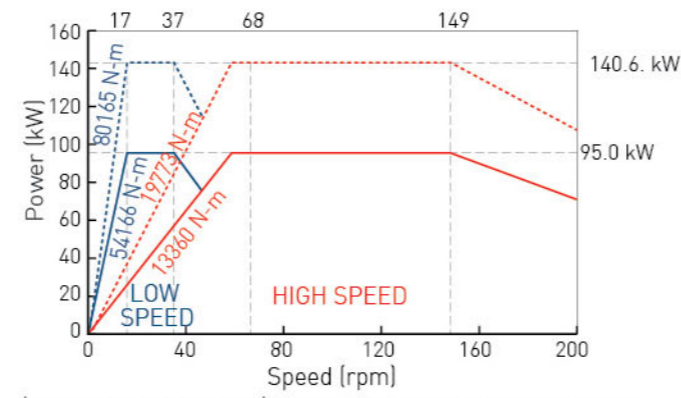

(MOTOR: SIEMENS 1PH8224-F) High speed ratio: 22.10 Low speed ratio: 89.60
VTL2000ATC-2R Series

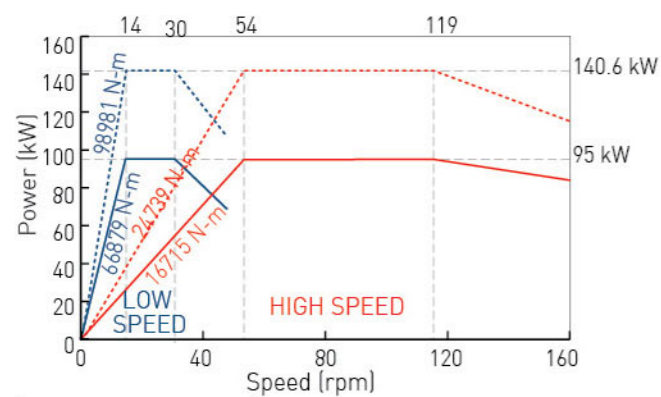

(MOTOR: SIEMENS 1PH8224-F) High speed ratio: 27.65 Low speed ratio: 110.63
VTL2500ATC-2R Series

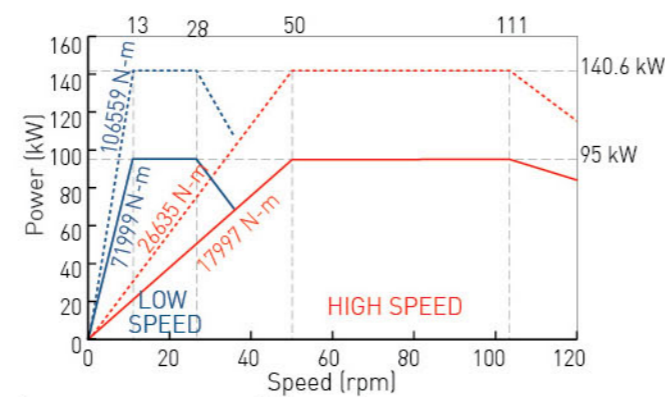

(MOTOR: SIEMENS 1PH8224-F) High speed ratio: 29.77 Low speed ratio: 119.1
VTL3000ATC-2R Series

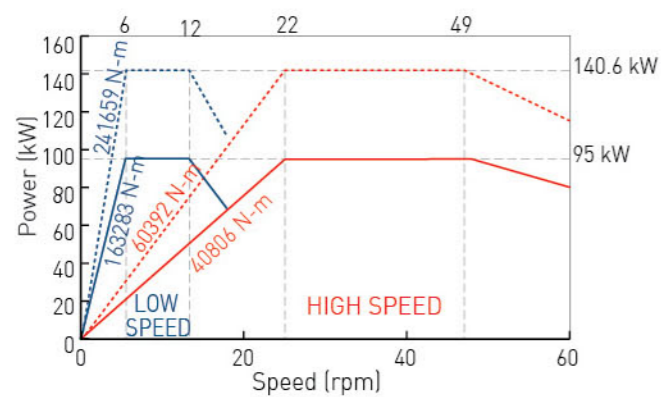

(MOTOR: SIEMENS 1PH8224-F) High speed ratio: 67.50 Low speed ratio: 270.1
VTL3500ATC-2R Series

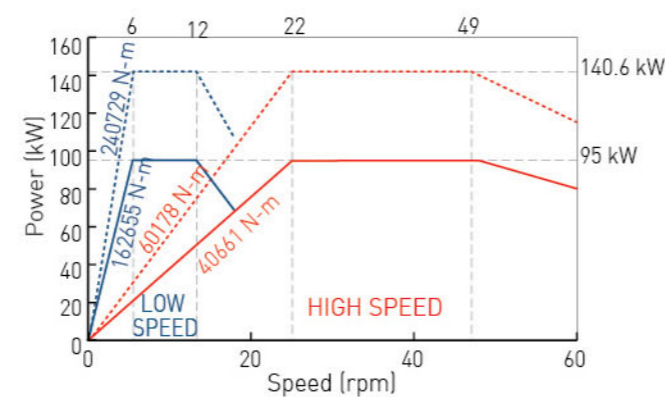

(MOTOR: SIEMENS 1PH8224-F) High speed ratio: 67.26 Low speed ratio: 269.06
VTL4000ATC-2R/VTL4500ATC-2R Series

2R+C series

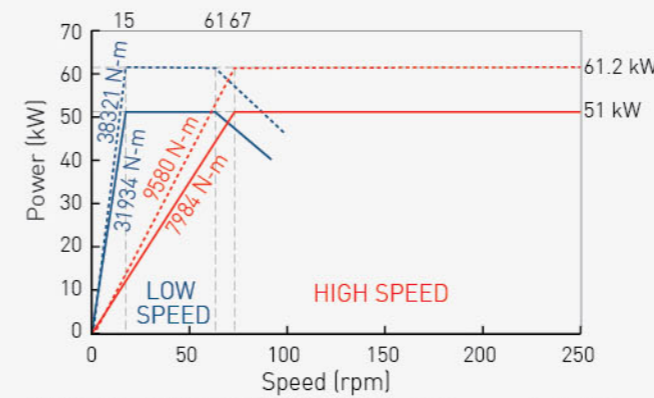

(MOTOR: SIEMENS 1PH8186-D) High speed ratio: 16.4 Low speed ratio: 65.6
VTL1600ATC+C-2R Series

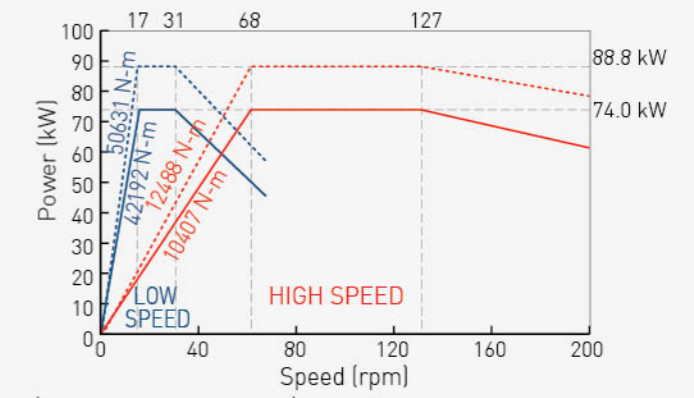

(MOTOR: SIEMENS 1PH8165-Fx2) High speed ratio: 22.10 Low speed ratio: 89.60
VTL2000ATC+C-2R Series

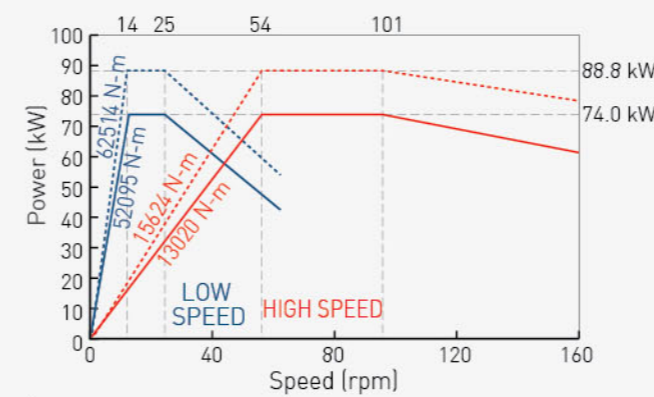

(MOTOR: SIEMENS 1PH8165-Fx2) High speed ratio: 27.65 Low speed ratio: 110.63
VTL2500ATC+C-2R Series

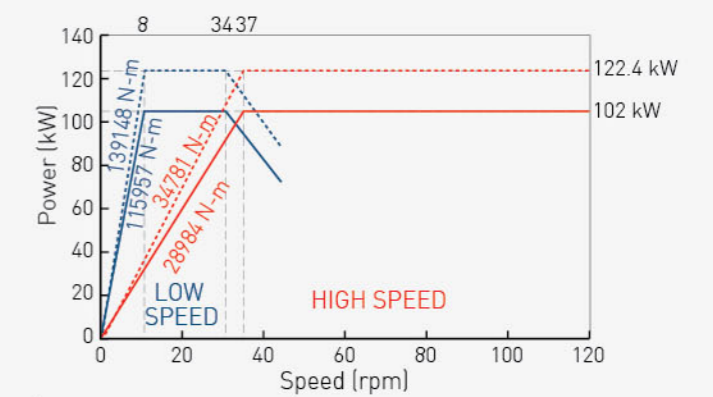

(MOTOR: SIEMENS 1PH8186-Dx2) High speed ratio: 29.77 Low speed ratio: 119.1
VTL3000ATC+C-2R Series

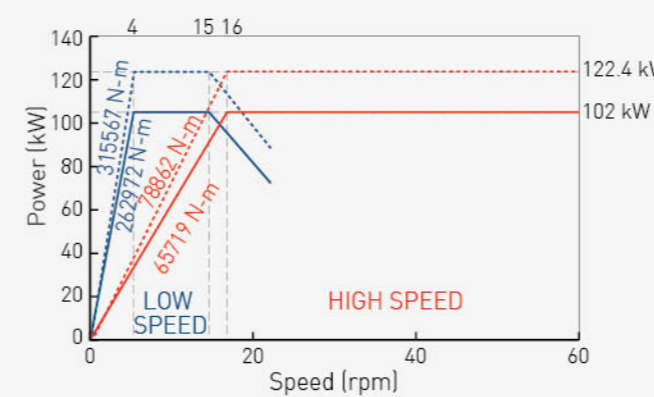

(MOTOR: SIEMENS 1PH8186-Dx2) High speed ratio: 67.50 Low speed ratio: 270.1
VTL3500ATC+C-2R Series

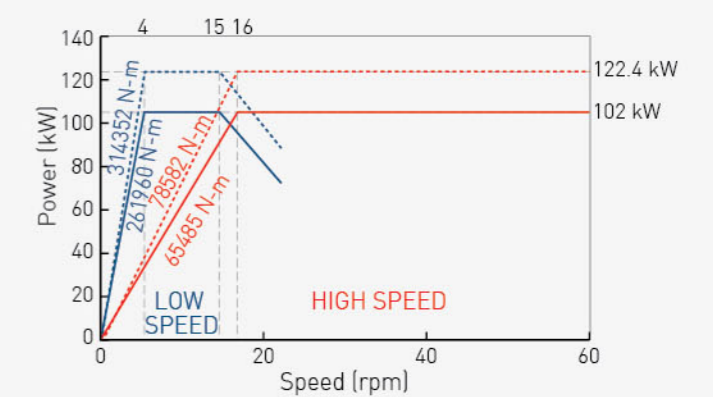

(MOTOR: SIEMENS 1PH8186-Dx2) High speed ratio: 67.26 Low speed ratio: 269.06
VTL4000ATC+C-2R/VTL4500ATC+C-2R Series



Live Spindle Features

Multitasking

The live spindle motor for ATC+C series coupled with the dual speed gearbox is located on top of the ram, driving the live spindle via transmission shaft. The use of the dual speed gearbox on the live spindle enables high torque output especially for face milling, end milling, drilling, and tapping processes.

Torque Chart (FANUC Live Spindle Motor)

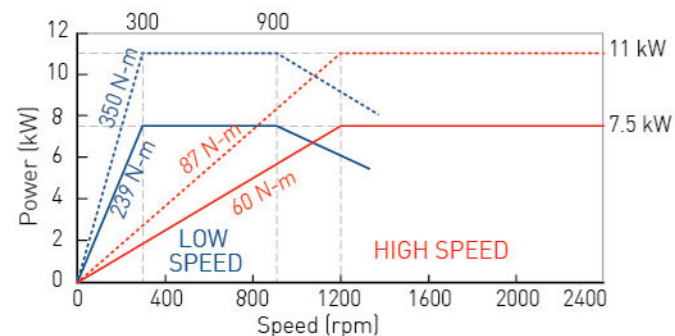

[MOTOR: FANUC α i18/8000] High speed ratio: 1.25 Low speed ratio: 5
VTL1000ATC+C/VTL1200ATC+C/VTL1600ATC+C Series

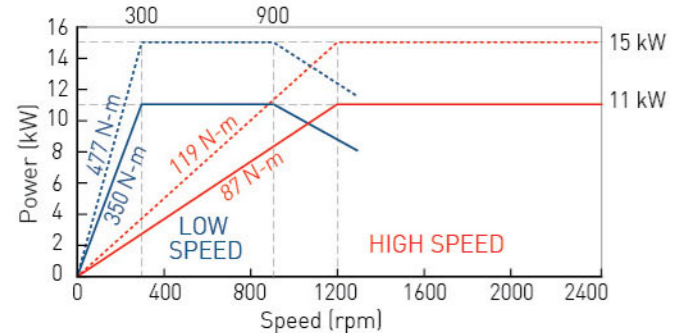

[MOTOR: FANUC α i12/8000HV] High speed ratio: 1.25 Low speed ratio: 5
VTL2000ATC+C/VTL2500ATC+C/VTL3000ATC+C/VTL3500ATC+C Series

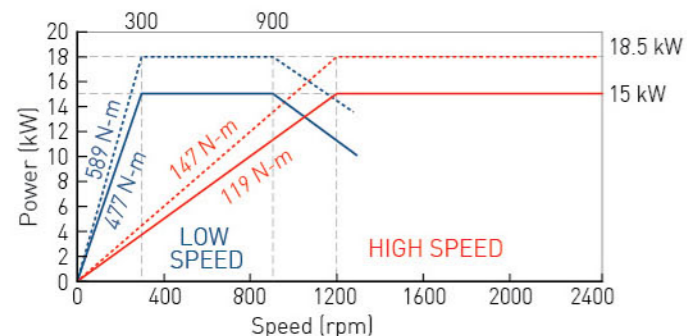

[MOTOR: FANUC α i15/8000HV] High speed ratio: 1.25 Low speed ratio: 5
VTL4000ATC+C/VTL4500ATC+C Series

Torque Chart (SIEMENS Live Spindle Motor)

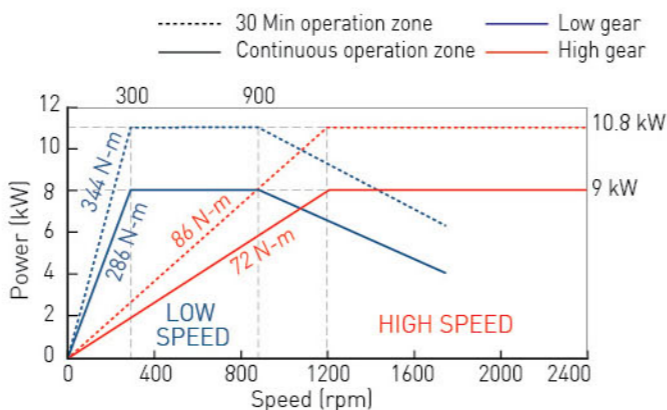

[MOTOR: SIEMENS 1PH8107-F] High speed ratio: 1.25 Low speed ratio: 5
VTL1000ATC+C/VTL1200ATC+C/VTL1600ATC+C Series

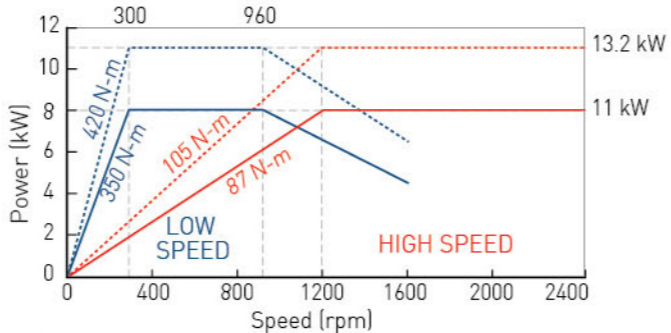

[MOTOR: SIEMENS 1PH8131-F] High speed ratio: 1.25 Low speed ratio: 5
VTL2000ATC+C/VTL2500ATC+C/VTL3000ATC+C/VTL3500ATC+C Series

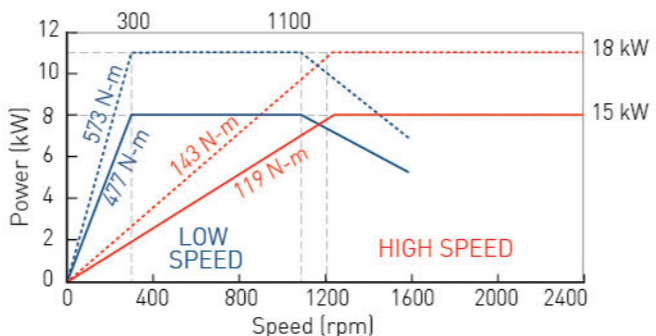

[MOTOR: SIEMENS 1PH8133-F] High speed ratio: 1.25 Low speed ratio: 5
VTL4000ATC+C/VTL4500ATC+C Series

Automatic Tool Changer

Disc Type Tool Magazine

The disc type, bi-directional ATC tool magazine is designed for the shortest route of tool selection. Rapid and reliable automatic tool change system efficiently reduces the cycle time and results greater productivity.



Chain Type Tool Magazine

The servo-driven chain type ATC tool magazine for VTL machines features:

- Innovative structure for simplified installation and saving maintenance cost.
- Continually running chain with minimal interlink gap has long service life, quiet operation.
- Highly-stable, simply-structured driving and chain-positioning modules.
- Available with 32, 48, 60 or more tool positions.



Tool Dimension BT 50

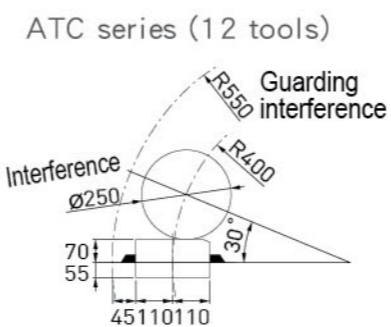
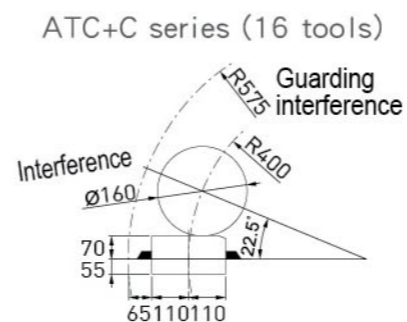

ATC+C series

ATC series

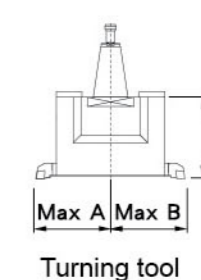
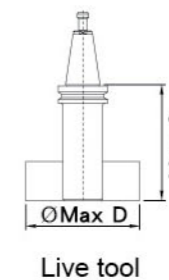
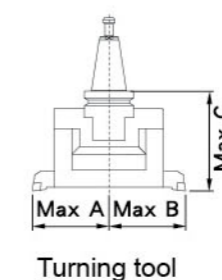

Model	Type	A	B	C	D
VTL1000-4500	ATC series	175	200	380	-
	ATC+C series	175	200	380	250

Unit: mm

Complex Machining

ATC Tooling System

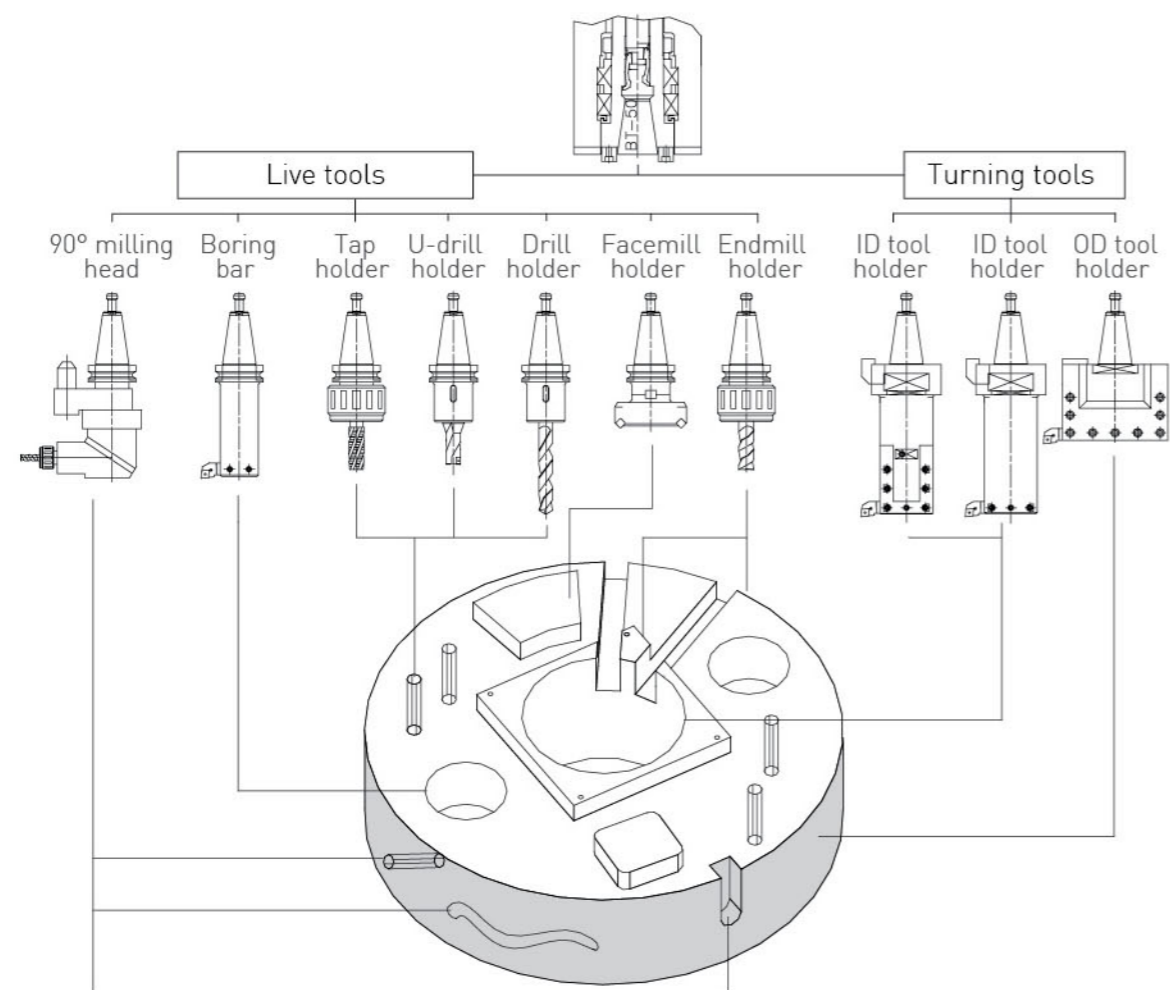

BT-50 Turning Tool Holder

ATC series

ATC+C series

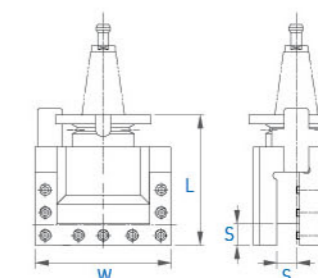
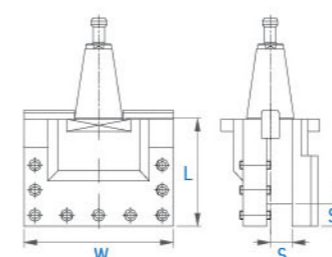

			Dual contact				
Model	W	L	S	Model	W	L	S
BT50-STST16032	220	160	32	BT50-DTST16032	220	160	32
BT50-STST16040	220	160	40	BT50-DTST16040	220	160	40
BT50-STMT16032	250	160	32	BT50-DTMT16032	250	160	32
BT50-STMT16040	250	160	40	BT50-DTMT16040	250	160	40

			Dual contact				
Model	W	L	S	Model	W	L	S
BT50-SMST19732	220	197	32	BT50-DMST21032	220	210	32
BT50-SMST19740	220	197	40	BT50-DMST21040	220	210	40
BT50-SMMT19732	250	197	32	BT50-DMMT21032	250	210	32
BT50-SMMT19740	250	197	40	BT50-DMMT21040	250	210	40

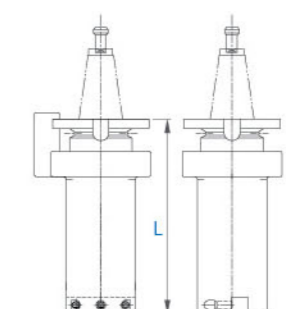
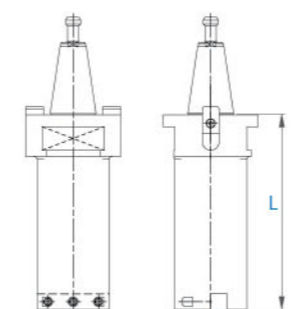

			Dual contact				
Model	∅D	L	S	Model	∅D	L	S
BT50-STBB20025	200	25	100	BT50-DTBB20025	200	25	100
BT50-STBB30025	300	25	110	BT50-DTBB30025	300	25	110

			Dual contact				
Model	∅D	L	S	Model	∅D	L	S
BT50-SMBB20025	200	25	100	BT50-DMBB20025	200	25	100
BT50-SMBB30025	300	25	110	BT50-DMBB30025	300	25	110

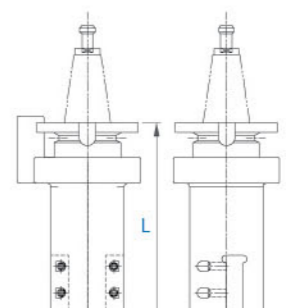
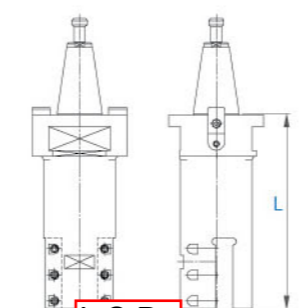

			Dual contact				
Model	∅D	L	S	Model	∅D	L	S
BT50-STBT20025	200	25	100	BT50-DTBT20025	200	25	100
BT50-STBT30025	300	25	110	BT50-DTBT30025	300	25	110

			Dual contact				
Model	∅D	L	S	Model	∅D	L	S
BT50-SMBT20025	200	25	100	BT50-DMBT20025	200	25	100
BT50-SMBT30025	300	25	110	BT50-DMBT30025	300	25	110

BT-50 Live tool holder

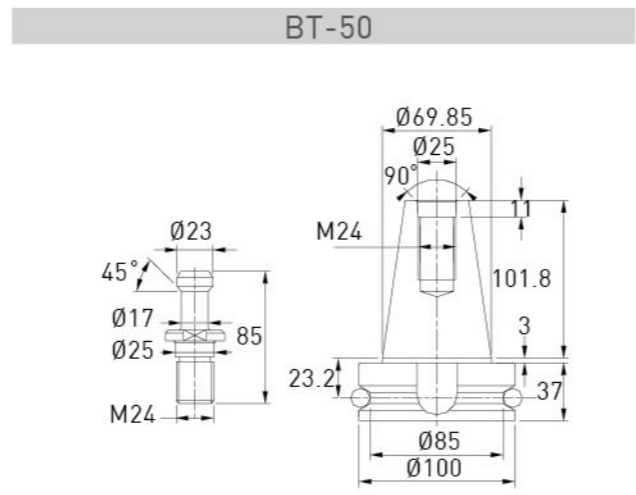

BT + Coromant Capto® System (ATC series) ※DT Dual contact

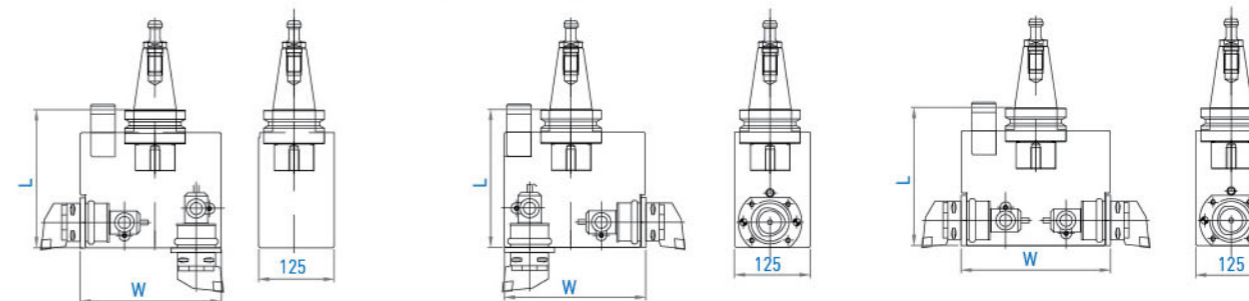

Model	W	L
BT50-STST228-R-C6-HV	234	228
BT50-DTST228-R-C6-HV	234	228

Model	W	L
BT50-STST228-R-C6-VH	234	228
BT50-DTST228-R-C6-VH	234	228

Model	W	L
BT50-STST228-R-C6-HH	247	228
BT50-DTST228-R-C6-HH	247	228

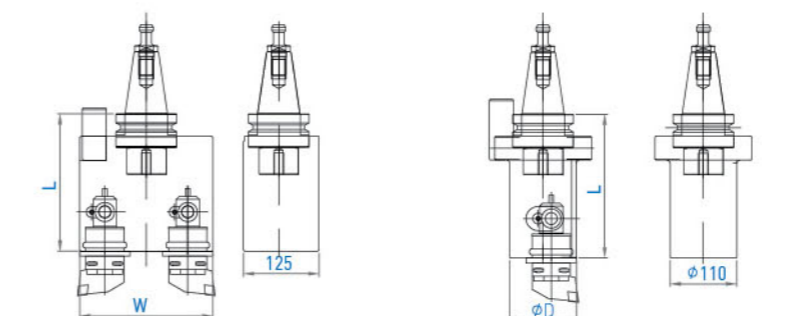

Model	W	L
BT50-STBT238-R-C6-VV	220	228
BT50-DTBT238-R-C6-VV	220	228

Model	ØD	L
BT50-STBT238-R-C6-V	110	238
BT50-DTBT238-R-C6-V	110	238

ATC+C series (Live tool holder)

Side lock chuck

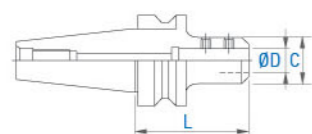

Model	L	C	D
BT50-SLA20-105	105	50	20
BT50-SLA25-105	105	55	25
BT50-SLA32-105	105	60	32
BT50-SLA40-105	105	80	40
BT50-SLA50.8-105	105	95	50.8

Facemill holder (Milling cutter excluded)

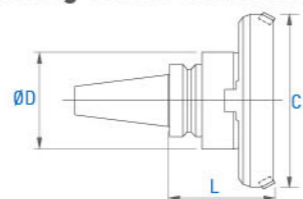

Model	L	C	D
BT50-FMA25.4-105	155	80	60
BT50-FMA31.75-105	160	100	70
BT50-FMA38.1-75	130	125	85
BT50-FMA50.8-75	135	150	95

Collet chuck

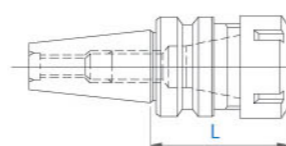

Model	L	Clamping range	Collet type
BT50-ER20-100	100	1-13	ER-20
BT50-ER32-100	100	3-20	ER-32
BT50-ER40-100	100	4-26	ER-40

BT + Coromant Capto® System (ATC+C series) ※DM Dual contact

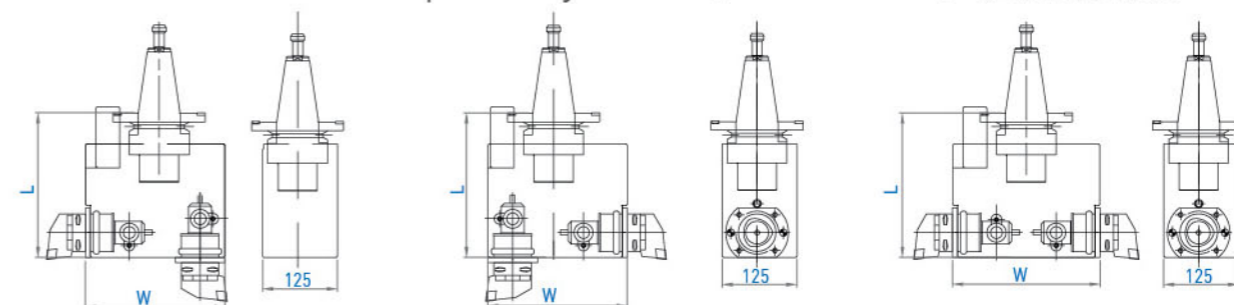

Model	W	L
BT50-SMST242-R-C6-HV	234	242
BT50-DMST242-R-C6-HV	234	242

Model	W	L
BT50-SMST242-R-C6-VH	234	242
BT50-DMST242-R-C6-VH	234	242

Model	W	L
BT50-SMST242-R-C6-HH	247	242
BT50-DMST242-R-C6-HH	247	242

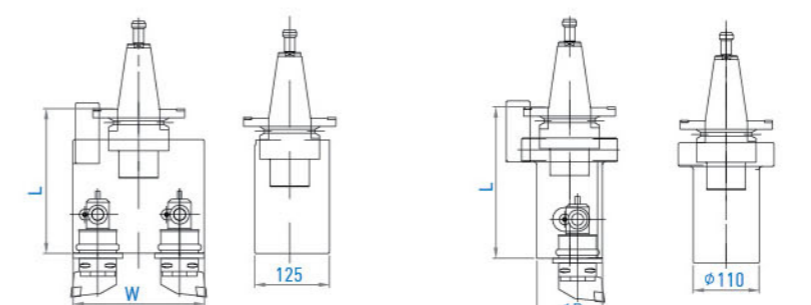

Model	W	L
BT50-SMST242-R-C6-VV	220	242
BT50-DMST242-R-C6-VV	220	242

Model	ØD
BT50-SMST253-R-C6-V	110 253
BT50-DMST253-R-C6-V	110 253

Model Definition

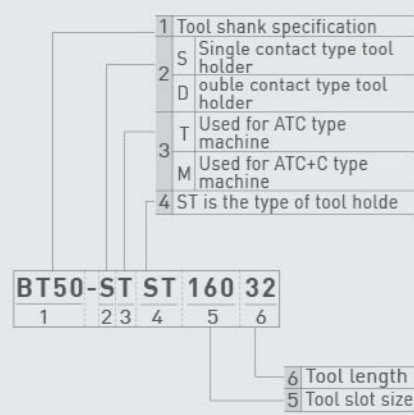

Boring bar (Rough boring)

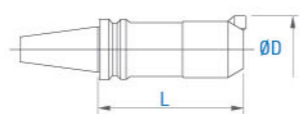

Model	L	D
BT50-BSB62-300	300	62-90
BT50-BSB72-285	285	72-110
BT50-BSB105-285	285	105-160

Tap holder

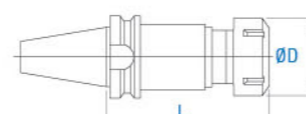

Model	L	D	Tapping range
BT50-TER16	80	28	M4-M10
BT50-TER40	117	63	M6-M27

Model Definition

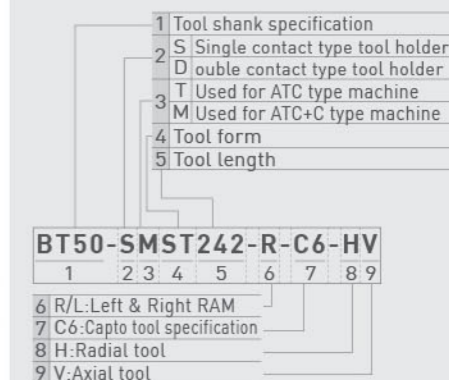

※Capto C6 cutting tools are not included, if you have any questions or need further information, please contact You Ji overseas sales department.

Safety & Operator-friendliness

HMI - Human Machine Interface

Tool monitoring system

Tool monitoring system is one of the safety functions to protect the tool and spindle against possible damages caused by tool wear, breakage, or any other factors lead to abnormal load. This system is developed with following features:

- Easy operation
- Optimum feedrate control
- Longer tool life
- Higher efficiency

Task manager

All-in-one screen shows all the work-related information in one screen, displayed info including:

- Parts program
- Mechanical coordinates
- Spindle load
- Axes load
- Real-time cut monitoring



Safety features

The VTL Series machines are very safe to use as they are designed to be as safe as possible. We are always looking for ways to improve all aspects of machine safety - including clamping stroke sensor, door interlock, safety window, etc. - to create the most safe and comfortable working environment for worldwide You Ji machine users.



Safety window



Clamping stroke sensor

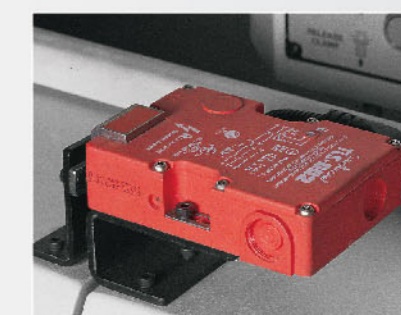

Door interlock



VTL1200ATC Valve



VTL1200ATC
Combustion chamber part



VTL1000ATC Water valve



VTL1000ATC+C
Motor housing



VTL1200ATC Pump



VTL1000ATC
Elevator part



VTL1200ATC
Rolled wheel



VTL1200ATC
Water valve



VTL1600ATC Rolled wheel



VTL2000ATC Engine case



VTL1600ATC+C
Water valve



VTL1000ATC Elevator part



VTL2000ATC Motor housing



VTL2500ATC+C Valve



VTL2500ATC+C Graphite



VTL3000ATC+C Wind power
generator-rotor machining



VTL1600ATC+C
Hydraulic cylinder

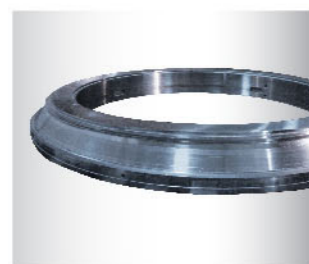

VTL4000ATC Bearing ring



VTL4000ATC+C Bearing ring



VTL3000ATC+C Wind power
generator-stator machining

Machining Range

1Rtype

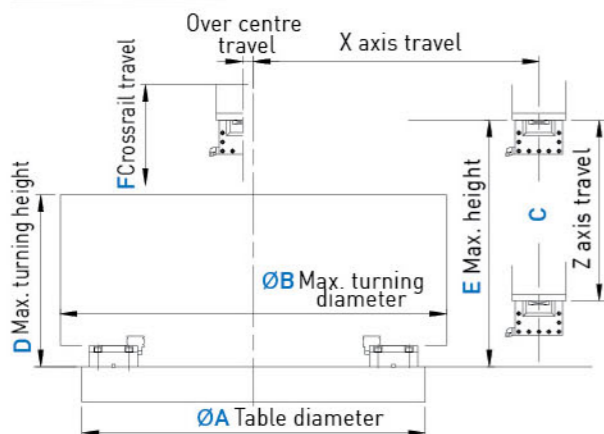

2Rtype

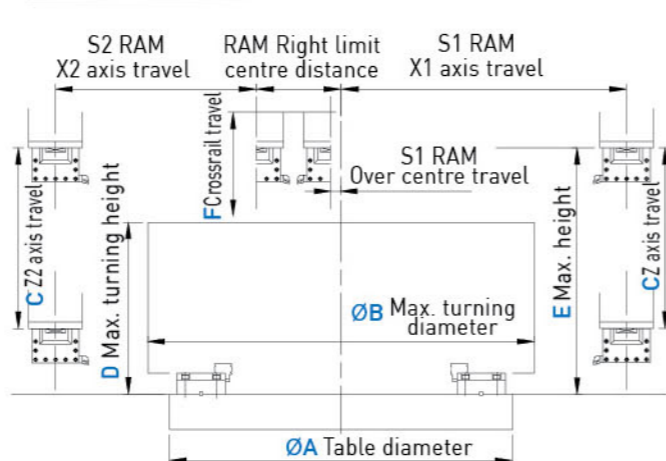

Model	A	B	C	D	E	F	Remark
VTL1000ATC(+C)	1000	1100	800	1000	1215	500	
VTL1200ATC(+C)			900	1200	1510	800	
VTL1200ATC- I	1250	1350	900	1600	1910	1200	
VTL1200ATC- II			1200	1800	2110	1400	
VTL1600ATC(+C)			900	1200	1530	800	(2R)
VTL1600ATC- I	1600	1800	900	1600	1930	1200	(2R)
VTL1600ATC- II			1200	1800	2130	1400	(2R)
VTL2000ATC(+C)			950	1600	2050	1150	(2R)
VTL2000ATC- I	2000	2300	1200	2000	2450	1550	(2R)
VTL2000ATC- II			1400	2000	2450	1550	(2R)
VTL2500ATC(+C)			1200	1600	2050	1150	(2R)
VTL2500ATC- I	2500	2800	1200	2000	2450	1550	(2R)
VTL2500ATC- II			1400	2000	2450	1550	(2R)

Model	A	B	C	D	E	F	Remark
VTL3000ATC(+C)				1600	1900	1200	(2R)
VTL3000ATC- I	3000	3300	1500	2200	2500	1400	(2R)
VTL3000ATC- II				2800	3100	2000	(2R)
VTL3500ATC(+C)				1600	1900	1200	(2R)
VTL3500ATC- I	3500	3800	1500	2200	2500	1400	(2R)
VTL3500ATC- II				2800	3100	2000	(2R)
VTL4000ATC(+C)				1500	1800	1200	(2R)
VTL4000ATC- I	4000	4300	1500	2100	2400	1400	(2R)
VTL4000ATC- II				2700	3000	2000	(2R)
VTL4500ATC(+C)				1500	1800	1200	(2R)
VTL4500ATC- I	4500	4800	1500	2100	2400	1400	(2R)
VTL4500ATC- II				2700	3000	2000	(2R)

Unit: mm

Unit: mm

2R

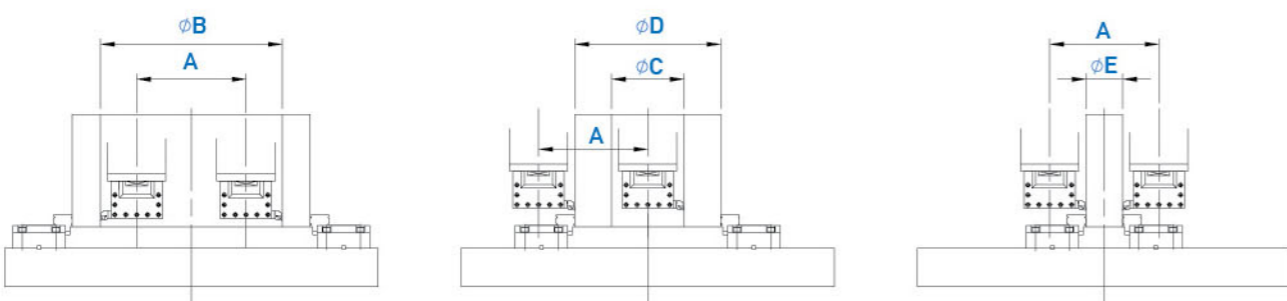

Model	A	B	C	D	E
VTL1600-2R series	800	1200	340	1400	560
VTL2000-2R series	920	1240	340	1500	600
VTL2500-2R series	950	1270	340	1560	630
VTL3000-2R series	1400	1700	400	2500	1100
VTL3500-2R series	1400	1700	400	2500	1100
VTL4000-2R series	1400	1700	400	2500	1100
VTL4500-2R series	1400	1700	400	2500	1100

Unit: mm

X axis Travel Diagram

1R

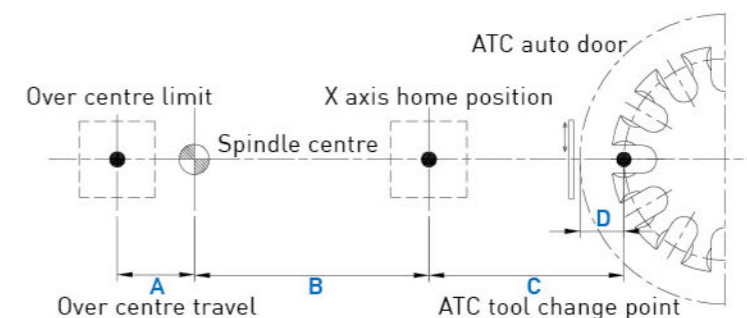

Model	A	B	C	D
VTL1000 series	400	720	400	175
VTL1200 series	600	875	400	175
VTL1600 series	800	1015	400	175
VTL2000 series	1000	1350	400	175
VTL2500 series	900	1600	400	175
VTL3000 series	1500	1650	600	175
VTL3500 series	1500	1650	600	175
VTL4000 series	2000	2350	600	175
VTL4500 series	2000	2650	600	175

Unit: mm

VTL 1600-4500-2R

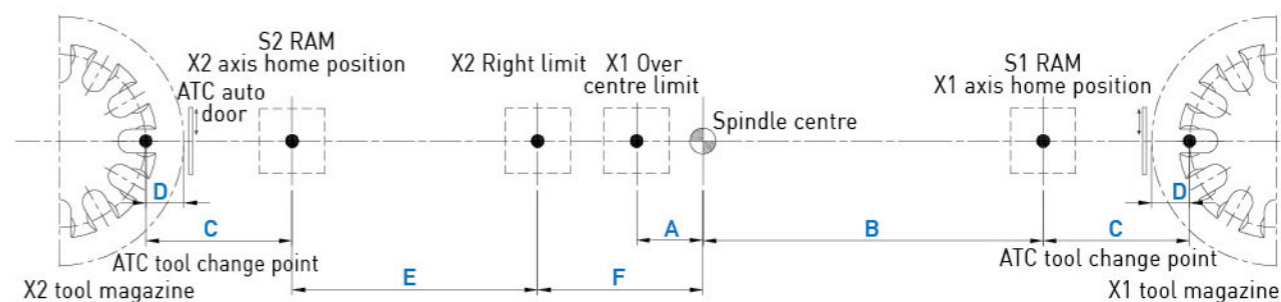

Model	A	B	C	D	E	F
VTL1600-2R series	100	1225	400	175	805	320
VTL2000-2R series	50	1350	400	175	700	650
VTL2500-2R series	50	1600	400	175	950	650
VTL3000-2R series	50	1650	600	175	950	700
VTL3500-2R series	50	1650	600	175	950	700
VTL4000-2R series	50	2350	600	175	1650	700
VTL4500-2R series	50	2650	600	175	1950	700

Unit: mm

Diagram of Working Table

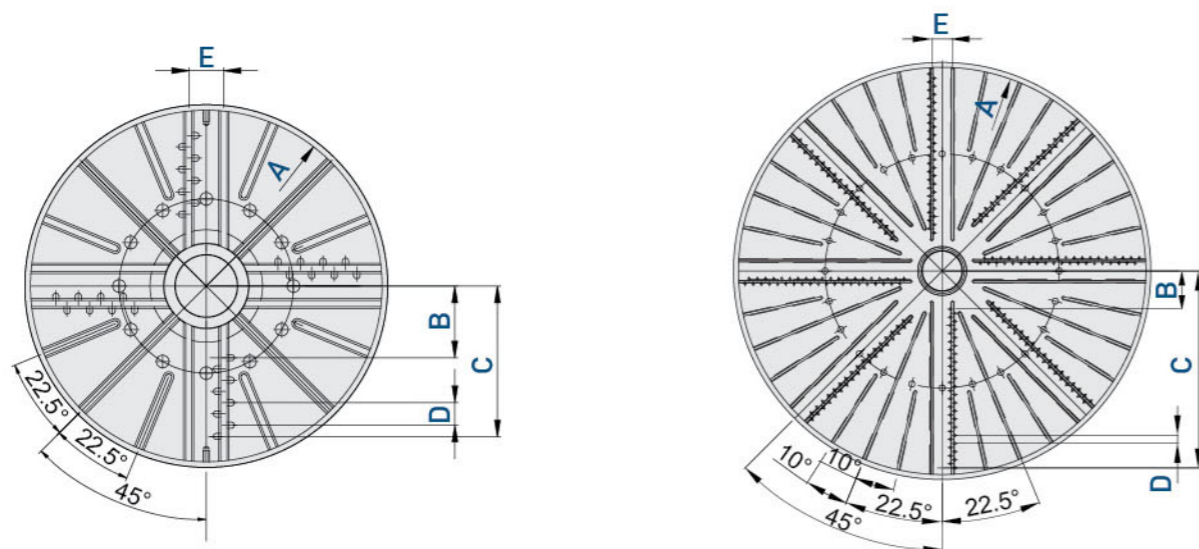

Model	A	B	C	D	E
VTL1000 series	Ø1000	240	440	80	125
VTL1200 series	Ø1250	255	535	80	125
VTL1600 series	Ø1600	255	775	80	125
VTL2000 series	Ø2000	255	895	80	125

Unit: mm

Model	A	B	C	D	E
VTL2500 series	Ø2500	255	1175	80	125
VTL3000 series	Ø3000	375	1463	80	205
VTL3500 series	Ø3500	375	1703	80	205
VTL4000 series	Ø4000	375	1935	80	205
VTL4500 series	Ø4500	375	2175	80	205

Unit: mm

Inside & outside clamping for chuck jaws

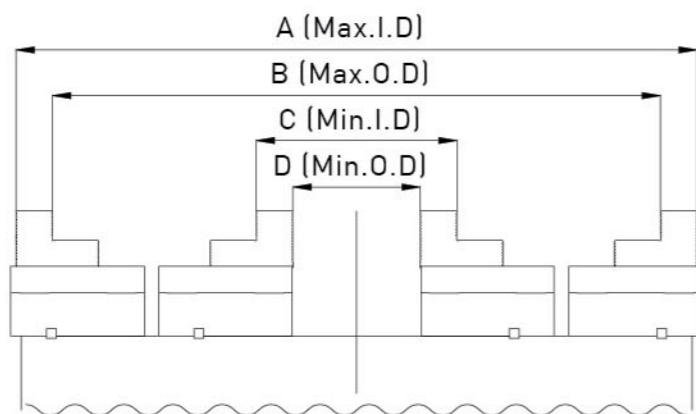

Model	A	B	C	D
VTL1000 series	Ø1000	870	370	250
VTL1200 series	Ø1180	1060	400	280
VTL1600 series	Ø1580	1460	400	280
VTL2000 series	Ø1900	1780	400	280
VTL2500 series	Ø2460	2340	480	360

Unit: mm

Model	A	B	C	D
VTL3000 series	Ø2756	2585	1025	845
VTL3500 series	Ø3425	3065	1025	845
VTL4000 series	Ø3710	3530	1090	910
VTL4500 series	Ø4190	4010	1090	910

Unit: mm

RAM Interference

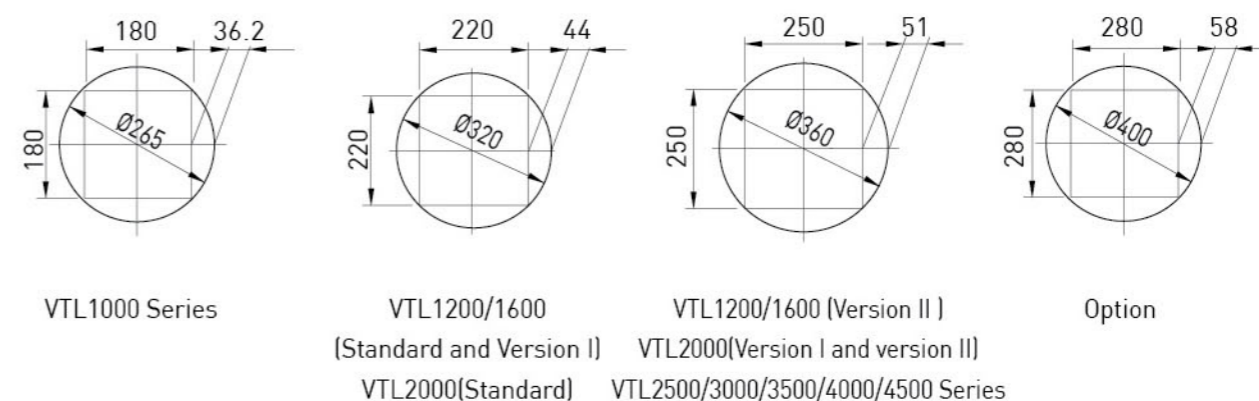

Dimension of Chuck Jaws

4 T VTL1000/1200/1600/2000/2500 series

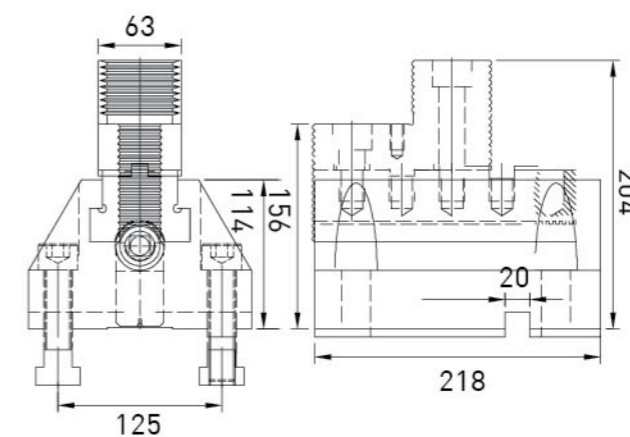

8 T VTL3000/3500/4000/4500 series

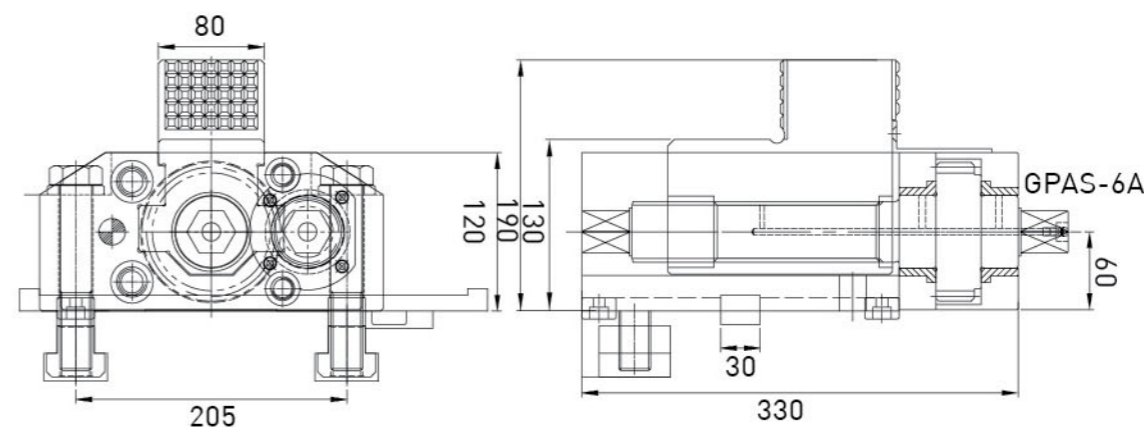

Machine Layout Dimension

VTL1000~2500 ATC

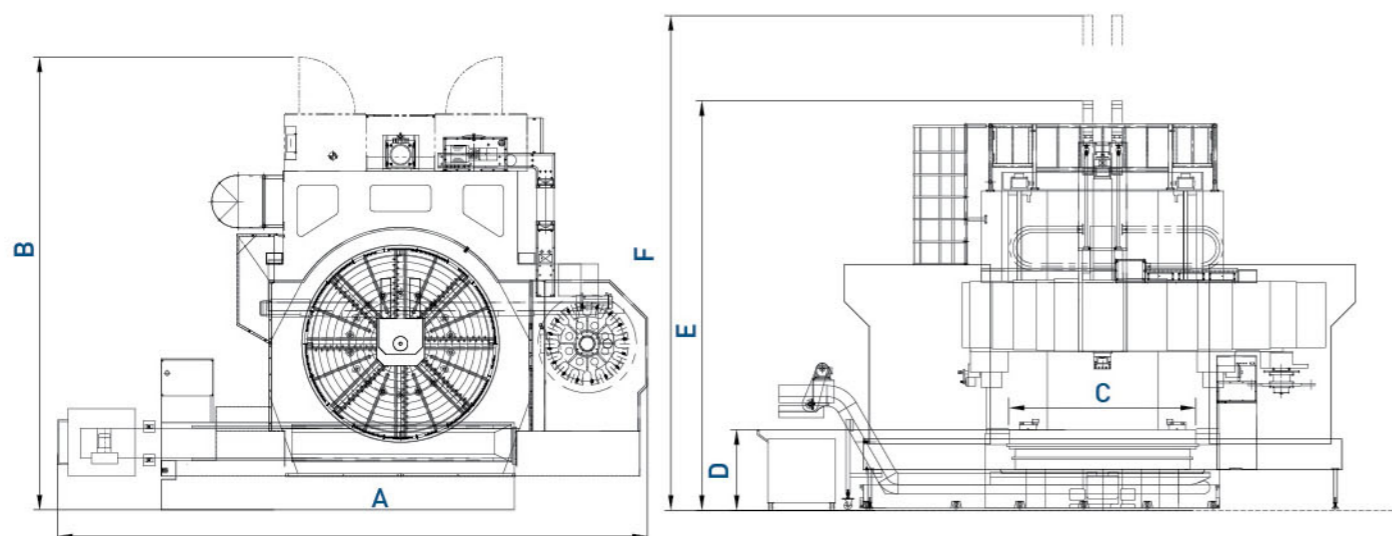

VTL3000~4500 ATC

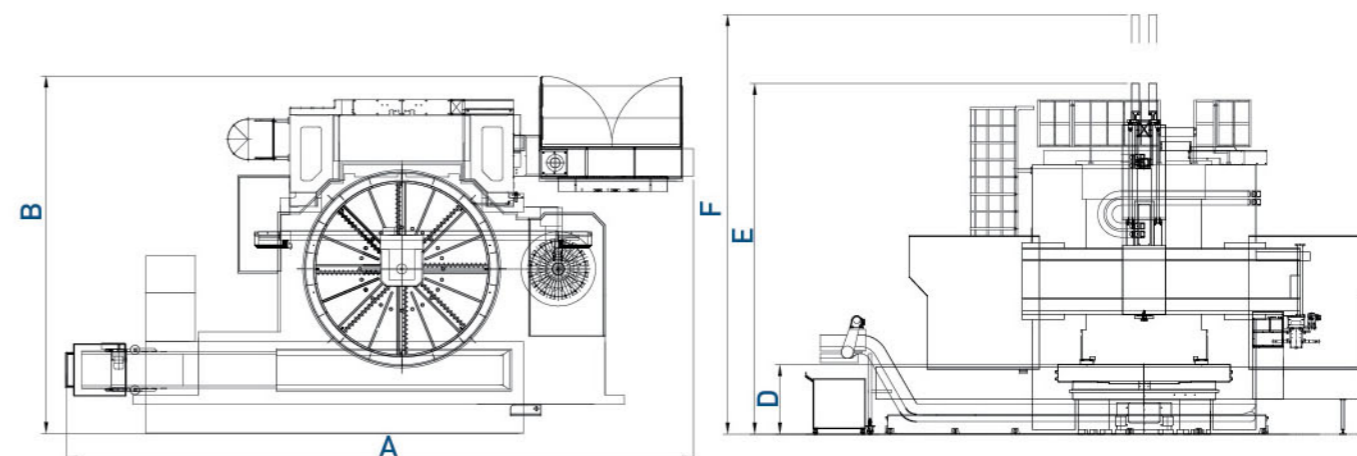

Model	A	B	C	D	E	F
VTL1000ATC	3850	4620	1000	980	4350	4850
VTL1000ATC+C	3850	4620	1000	980	4450	4950
VTL1200ATC	4260	5580	1250	970	4600	5400
VTL1200ATC+C	4260	5580	1250	970	4600	5400
VTL1200ATC- I	4260	5580	1250	970	4750	5800
VTL1200ATC- II	4260	5580	1250	970	5200	6600
VTL1600ATC	4510	5850	1600	970	4600	5400
VTL1600ATC+C	4510	5850	1600	970	4600	5400
VTL1600ATC- I	4510	5850	1600	970	4750	5800
VTL1600ATC- II	4510	5850	1600	970	5200	6500

Unit: mm

Model	A	B	C	D	E	F
VTL2000ATC	4650	6850	2000	1080	5120	6270
VTL2000ATC+C	4650	6850	2000	1080	5140	6290
VTL2000ATC- I	4650	6850	2000	1080	5520	7070
VTL2000ATC- II	4650	6850	2000	1080	6120	7670
VTL2500ATC	5130	7550	2500	1080	5500	6650
VTL2500ATC+C	5130	7550	2500	1080	5500	6650
VTL2500ATC- I	5130	7550	2500	1080	5500	7050
VTL2500ATC- II	5130	7550	2500	1080	6150	7700

Unit: mm

Model	A	B	C	D	E	F
VTL3000ATC	7000	11000	3000	1210	6200	7400
VTL3000ATC+C	7000	11000	3000	1210	6200	7400
VTL3000ATC- I	7000	11000	3000	1210	6600	8000
VTL3000ATC- II	7000	11000	3000	1210	6600	8600
VTL3500ATC	8500	12500	3500	1210	6200	7400
VTL3500ATC+C	8500	12500	3500	1210	6200	7400
VTL3500ATC- I	8500	12500	3500	1210	6600	8000
VTL3500ATC- II	8500	12500	3500	1210	6600	8600

Unit: mm

Model	A	B	C	D	E	F
VTL4000ATC	9500	12500	4000	1330	6200	7400
VTL4000ATC+C	9500	12500	4000	1330	6200	7400
VTL4000ATC- I	9500	12500	4000	1330	6600	8000
VTL4000ATC- II	9500	12500	4000	1330	6600	8600
VTL4500ATC	9500	12500	4500	1385	6600	7800
VTL4500ATC+C	9500	12500	4500	1385	6600	7800
VTL4500ATC- I	9500	12500	4500	1385	6800	8200
VTL4500ATC- II	9500	12500	4500	1385	6800	8600

Unit: mm

VTL 2R Series

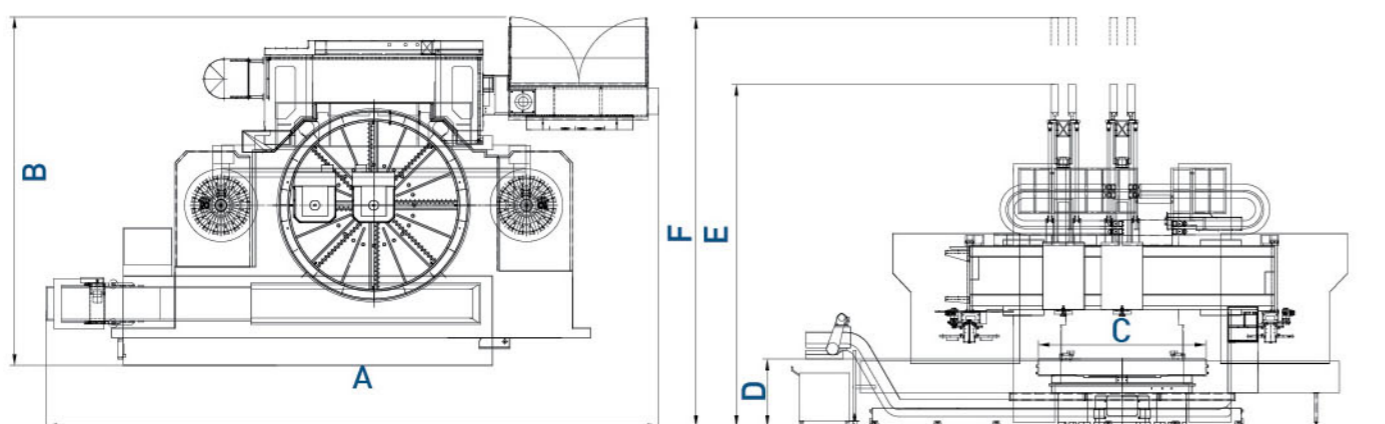

Model	A	B	C	D	E	F
VTL1600ATC-2R	5850	5000	1600	970	4600	5300
VTL2000ATC-2R	6900	5900	2000	1080	5300	6450
VTL2500ATC-2R	7920	6300	2500	1080	5400	6550
VTL3000ATC-2R	11000	7000	3000	1140	6200	7400
VTL3500ATC-2R	12500	8500	3500	1140	6200	7400
VTL4000ATC-2R	12500	8500	4000	1140	6200	7400
VTL4500ATC-2R	13000	10500	4500	1295	6400	7800

Unit: mm

Machine Specifications

Capacity		VTL1000		VTL1200				VTL1600				VTL2000				VTL2500			
Item	Unit	ATC	ATC+C	ATC	ATC-I	ATC-II	ATC+C	ATC	ATC-I	ATC-II	ATC+C	ATC	ATC-I	ATC-II	ATC+C	ATC	ATC-I	ATC-II	ATC+C
Capacity																			
Table diameter	mm	Ø1000	Ø1000	Ø1250	Ø1250	Ø1250	Ø1250	Ø1600	Ø1600	Ø1600	Ø1600	Ø2000	Ø2000	Ø2000	Ø2000	Ø2500	Ø2500	Ø2500	Ø2500
Max. swing diameter	mm	Ø1350	Ø1350	Ø1600	Ø1600	Ø1600	Ø1600	Ø2000	Ø2000	Ø2000	Ø2000	Ø2500	Ø2500	Ø2500	Ø2500	Ø3000	Ø3000	Ø3000	Ø3000
Max. turning diameter	mm	Ø1100	Ø1100	Ø1350	Ø1350	Ø1350	Ø1350	Ø1800	Ø1800	Ø1800	Ø1800	Ø2300	Ø2300	Ø2300	Ø2300	Ø2800	Ø2800	Ø2800	Ø2800
Max. turning height	mm	1000	1000	1200	1600	1800	1200	1200	1600	1800	1200	1600	2000	2000	1600	1600	2000	2000	1600
Max. work-piece weight	kg	4000	4000	5000	5000	5000	5000	8000	8000	8000	8000	10000	10000	10000	10000	15000	15000	15000	15000
Travel																			
X-axis travel	mm	-400, +720	-400, +720	-600, +875	-600, +875	-600, +875	-600, +875	-800, +1015	-800, +1015	-800, +1015	-800, +1015	-1000, +1350	-1000, +1350	-1000, +1350	-1000, +1350	-900, +1600	-900, +1600	-900, +1600	-900, +1600
Z-axis travel	mm	800	800	900	900	1200	900	900	900	1200	900	950	1200	1400	950	1200	1200	1400	1200
Vertical travel of crossrail	mm	500	500	800	1200	1400	800	800	1200	1400	800	1150	1550	1550	1150	1150	1550	1550	1150
Spindle (FANUC motor)																			
Spindle speed	RPM	1~160	1~160	1~150	1~150	1~150	1~150	1~70	1~70	1~70	1~70	1~50	1~50	1~50	1~50	1~40	1~40	1~40	1~40
Live spindle speed	Low	RPM	160~600	160~600	150~350	150~350	150~350	150~350	70~250	70~250	70~250	70~250	50~200	50~200	50~200	50~200	40~160	40~160	40~160
	High	RPM	1~1200	1~1200	1~1200	1~1200	1~1200	1~1200	1~1200	1~1200	1~1200	1~1200	1~1200	1~1200	1~1200	1~1200	1~1200	1~1200	1~1200
Max. table torque	Low	RPM	1200~2400	1200~2400	1200~2400	1200~2400	1200~2400	1200~2400	1200~2400	1200~2400	1200~2400	1200~2400	1200~2400	1200~2400	1200~2400	1200~2400	1200~2400	1200~2400	1200~2400
	High	N-m	10,757(1097)	10,757(1097)	10,682(1090)	10,682(1090)	10,682(1090)	10,682(1090)	24,502(2500)	24,502(2500)	24,502(2500)	24,502(2500)	55,777(5691)	55,777(5691)	55,777(5691)	66,933(6829)	68,869(7027)	68,869(7027)	68,869(7027)
Feed rate																			
X-axis rapid traverse	m/min	12	12	12	12	12	12	12	12	12	12	10	10	10	10	10	10	10	10
Z-axis rapid traverse	m/min	10	10	10	10	10	10	10	10	10	10	10	10	10	10	10	10	10	10
Cutting feed rate	mm/min	1~2000	1~2000	1~2000	1~2000	1~2000	1~2000	1~2000	1~2000	1~2000	1~2000	1~2000	1~2000	1~2000	1~2000	1~2000	1~2000	1~2000	1~2000
Manual feed rate	m/min	0~6	0~6	0~6	0~6	0~6	0~6	0~6	0~6	0~6	0~6	0~6	0~6	0~6	0~6	0~6	0~6	0~6	0~6
Automatic Tool Changer																			
Number of tool position		12	16	12	16	12	16	12	16	12	16	12	16	12	16	12	16	12	16
Type of tool shank		7/24 Taper BT-50	7/24 Taper BT-50	7/24 Taper BT-50	7/24 Taper BT-50	7/24 Taper BT-50	7/24 Taper BT-50	7/24 Taper BT-50	7/24 Taper BT-50	7/24 Taper BT-50	7/24 Taper BT-50	7/24 Taper BT-50	7/24 Taper BT-50	7/24 Taper BT-50	7/24 Taper BT-50	7/24 Taper BT-50	7/24 Taper BT-50	7/24 Taper BT-50	
Max. tool length of ATC	mm	380	380	380	380	380	380	380	380	380	380	380	380	380	380	380	380	380	380
Max. tool weight	kg	50	50	50	50	50	50	50	50	50	50	50	50	50	50	50	50	50	50
Max. loading weight of ATC	kg	600	800	600	800	600	800	600	800	600	800	600	800	600	800	600	800	600	800
Time of tool change (tool to tool)	sec	40	40	40	40	40	40	40	40	40	40	40	40	40	40	50	50	50	50
Controller (FANUC)																			
FANUC 0i-T										FANUC 0i-T									
FANUC motor																			
Spindle motor	kW	37/45 (aiI40)		37/45 (aiI40)				37/45 (aiI40)				60/75 (aiI60HV)				60/75 (aiI60HV)			
Live spindle motor	kW	7.5/11(aiI8)		7.5/11(aiI8)				7.5/11(aiI8)				11/15(aiI12HV)				11/15(aiI12HV)			
X-axis servo motor	kW	7 (a30i)		6 (a40i)				6 (a40i)				5.5(aiS40)				5.5(aiS40)			
Z-axis servo motor	kW	9(aiF40)		9(aiF40)				9(aiF40)				5.5(aiS40)				5.5(aiS40)			
CF-axis servo motor	kW	7 (aiF30)		7 (aiF30)				7 (aiF30)				5.5 (aiS40)				5.5 (aiS40)			
Coolant pump	kW	3		3				3				3				3			
Power capacity	KVA	85	105	85	105	85	105	85	105	85	105	115	130	115	130	115	130	115	130
Tank capacity																			
Hydraulic tank	L	60	130	130				130				130				130			
Coolant tank	L	750	750	550				550				900				1100			
Lubrication tank	L	4.6	4.6	4.6				4.6				4.6				4.6			
Machine dimension																			
Floor dimension	mm	4620 x 3850		5580 x 4260				5850 x 4510				6850 x 4650				7550 x 5130			
Machine height	mm	4850	4950	5400	5800	6600	5400	5400	5800	6500	5400	6270	7070	7670	6290	6650	7050	7700	6650
Machine weight	kg	21000	22000	33000	34500	36500	33500	37000	38000	39500	37500	49000	49500	50000	49500	55500	60000	60500	57000

※Specification is subject to change without prior notice

Machine Specifications

Capacity		VTL3000				VTL3500				VTL4000				VTL4500																			
Item	Unit	ATC	ATC-I	ATC-II	ATC+C	ATC	ATC-I	ATC-II	ATC+C	ATC	ATC-I	ATC-II	ATC+C	ATC	ATC-I	ATC-II	ATC+C																
Capacity																																	
Table diameter	mm	Ø3000	Ø3000	Ø3000	Ø3000	Ø3500	Ø3500	Ø3500	Ø3500	Ø4000	Ø4000	Ø4000	Ø4000	Ø4500	Ø4500	Ø4500	Ø4500																
Max. swing diameter	mm	Ø3400	Ø3400	Ø3400	Ø3400	Ø4100	Ø4100	Ø4100	Ø4100	Ø4600	Ø4600	Ø4600	Ø4600	Ø5100	Ø5100	Ø5100	Ø5100																
Max. turning diameter	mm	Ø3300	Ø3300	Ø3300	Ø3300	Ø3800	Ø3800	Ø3800	Ø3800	Ø4300	Ø4300	Ø4300	Ø4300	Ø4800	Ø4800	Ø4800	Ø4800																
Max. turning height	mm	1600	2200	2800	1600	1600	2200	2800	1600	1500	2100	2700	1500	1500	2100	2700	1500																
Max. work-piece weight	kg	20000	20000	20000	20000	20000	20000	20000	20000	30000	30000	30000	30000	30000	30000	30000	30000																
Travel																																	
X-axis travel	mm	-1500,+1650				-1500,+1650				-2000,+2350				-2000,+2650																			
Z-axis travel	mm	1500	1500	1500	1500	1500	1500	1500	1500	1500	1500	1500	1500	1500	1500	1500	1500																
Vertical travel of crossrail	mm	1200	1400	2000	1200	1200	1400	2000	1200	1200	1400	2000	1200	1200	1400	2000	1200																
Spindle (FANUC motor)																																	
Spindle speed	Low	RPM	1~40	1~40	1~40	1~40	1~14	1~14	1~14	1~14	1~14	1~14	1~14	1~14	1~14	1~14	1~14																
	High	RPM	40~120	40~120	40~120	40~120	14~60	14~60	14~60	14~60	14~60	14~60	14~60	14~60	14~60	14~60	14~60																
Live spindle speed	Low	RPM	/				1~1200				/				1~1200																		
	High	RPM	/				1200~2400				/				1200~2400																		
Max. table torque	N-m	67,605(6898)				81,126(8278)				309,379(31,569)				336,282(34,314)				308,188(31,447)				334,987(34,182)				308,188(31,447)				334,987(34,182)			
Feed rate																																	
X-axis rapid traverse	m/min	6				6				6				6				6															
Z-axis rapid traverse	m/min	10				10				10				10				10															
Cutting feed rate	mm/min	1~2000				1~2000				1~2000				1~2000				1~2000															
Manual feed rate	m/min	0~6				0~6				0~6				0~6				0~6															
Automatic Tool Changer																																	
Number of tool position		16				16				16				16																			
Type of tool shank		7/24 Taper BT-50				7/24 Taper BT-50				7/24 Taper BT-50				7/24 Taper BT-50																			
Max. tool length of ATC	mm	400				400				400				400																			
Max. tool weight	kg	50				50				50				50																			
Max. loading weight of ATC	kg	800				800				800				800																			
Time of tool change (tool to tool)	sec	60				60				60				60																			
Controller (FANUC)																																	
FANUC 0i-T																																	
FANUC motor																																	
Spindle motor	kW	60/75(ai160HV)				37/45(ai140HV)x2				100/120(ai100HV)				60/75(ai160HV)x2				100/120(ai100HV)				60/75(ai160HV)x2				100/120(ai100HV)				60/75(ai160HV)x2			
Live spindle motor	kW	/				11/15(ai112HV)				/				11/15(ai12HV)				/				15/18(ai15HV)				/				15/18(ai15HV)			
X-axis servo motor	kW	5.5 (aiS40)				5.5 (aiS40)				5.5 (aiS40)				5.5 (aiS40)				5.5 (aiS40)															
Z-axis servo motor	kW	5.5 (aiS40)				5.5 (aiS40)				5.5 (aiS40)				5.5 (aiS40)				5.5 (aiS40)															
Coolant pump	kW	3				3				3				3				3															
Power capacity	KVA	115				185				115				185				130				200				175				200			
Tank capacity																																	
Hydraulic tank	L	130				130				130				130				130															
Coolant tank	L	2000				2500				2500				2500				2800															
Lubrication tank	L	4.6+8				4.6+8				4.6+8				4.6+8				4.6+8															
Machine dimension																																	
Floor dimension	mm	11000 x 7000				12500 x 8500				12500 x 9500				12500 x 9500																			
Machine height	mm	7400	8000	8600	7400	7400	8000	8600	7400	7400	8000	8600	7400	7800	8200	8600	7800																
Machine weight	kg	70000	80000	90000	75000	90000	100000	110000	90000	100000	110000	120000	105000	125000	135000	145000	130000																

※本產品若有更改設計恕不另行通知 without prior notice

Machine Specifications-2R Series

Capacity		VTL1600		VTL2000		VTL2500		VTL3000		VTL3500		VTL4000		VTL4500	
Item	Unit	ATC-2R	ATC+C-2R	ATC-2R	ATC+C-2R	ATC-2R	ATC+C-2R	ATC-2R	ATC+C-2R	ATC-2R	ATC+C-2R	ATC-2R	ATC+C-2R	ATC-2R	ATC+C-2R
Capacity															
Table diameter	mm	Ø1600	Ø1600	Ø2000	Ø2000	Ø2500	Ø2500	Ø3000	Ø3000	Ø3500	Ø3500	Ø4000	Ø4000	Ø4500	Ø4500
Max. swing diameter	mm	Ø2000	Ø2000	Ø2500	Ø2500	Ø3000	Ø3000	Ø3500	Ø3500	Ø4100	Ø4100	Ø4600	Ø4600	Ø5100	Ø5100
Max. turning diameter	mm	Ø1800	Ø1800	Ø2300	Ø2300	Ø2800	Ø2800	Ø3400	Ø3400	Ø3800	Ø3800	Ø4300	Ø4300	Ø4800	Ø4800
Max. turning height	mm	1200	1200	1600	1600	1600	1600	1600	1600	1600	1600	1500	1500	1500	1500
Max. work-piece weight	kg	8000	8000	10000	10000	15000	15000	20000	20000	20000	20000	30000	30000	30000	30000
Travel															
X-axis travel	mm	X2:-1225,-320/X1:-100,1225		X2:-1350,-650 / X1:-50,1350		X2:-1600,-650 / X1:-50,1600		X2:-1650,-700 / X1:-50,1650		X2:-1650,-700 / X1:-50,1650		X2:-2350,-700 / X1:-50,2350		X2:-2650,-700 / X1:-50,2650	
Z-axis travel	mm	900	900	950	950	1200	1200	1500	1500	1500	1500	1500	1500	1500	1500
Vertical travel of crossrail	mm	800	800	1150	1150	1150	1150	1200	1200	1200	1200	1200	1200	1000	1000
Spindle (FANUC motor)															
Spindle speed	Low	RPM	1~60	1~60	1~45	1~45	1~35	1~35	1~40	1~40	1~14	1~14	1~14	1~14	1~14
	High	RPM	60~250	60~250	45~200	45~200	35~160	35~160	40~120	40~120	14~60	14~60	14~60	14~60	14~60
Live spindle speed	Low	RPM	/	1~1200	/	1~1200	/	1~1200	/	1~1200	/	1~1200	/	1~1200	/
	High	RPM	/	1200~2400	/	1200~2400	/	1200~2400	/	1200~2400	/	1200~2400	/	1200~2400	/
Max. table torque	N-m	40,837(4167)	40,837(4167)	102,630(10,472)	66,933(6829)	126,718(13,920)	82,642(8432)	136,420(13,920)	148,283(15,130)	309,379(31,569)	336,282(34,314)	308,188(31,447)	334,987(34,182)	308,188(31,447)	334,987(34,182)
Feed rate															
X-axis rapid traverse	m/min	12		10		10		6		6		6		6	
Z-axis rapid traverse	m/min	10		10		10		10		10		10		10	
Cutting feed rate	mm/min	1~2000		1~2000		1~2000		1~2000		1~2000		1~2000		1~2000	
Manual feed rate	m/min	0~6		0~6		0~6		0~6		0~6		0~6		0~6	
Automatic Tool Changer															
Number of tool position		12x2	16+12	12x2	16+12	12x2	16+12	16x2	16x2	16x2	16x2	16x2	16x2	16x2	16x2
Type of tool shank		7/24 Taper BT-50		7/24 Taper BT-50		7/24 Taper BT-50		7/24 Taper BT-50		7/24 Taper BT-50		7/24 Taper BT-50		7/24 Taper BT-50	
Max. tool length of ATC	mm	380		380		380		380		380		380		380	
Max. tool weight	kg	50		50		50		50		50		50		50	
Max. loading weight of ATC	kg	600	800	600	800	600	800	800	800	800	800	800	800	800	800
Time of tool change (tool to tool)	sec	40		50		50		60		60		60		60	
Controller (FANUC)															
FANUC Oi-T															
FANUC motor															
Spindle motor	kW	100/120(ai100HV)	37/45(ai140HV)x2	100/120(ai100HV)	37/45(ai140HV)x2	100/120(ai100HV)	60/75 (ai160HV)x2	100/120(ai100HV)	60/75 (ai160HV)x2	100/120(ai100HV)	60/75 (ai160HV)x2	100/120(ai100HV)	60/75 (ai160HV)x2	100/120(ai100HV)	60/75 (ai160HV)x2
Live spindle motor	kW	/	7.5/11(ai18)	/	11/15(ai12HV)	/	11/15(ai12HV)	/	11/15(ai12HV)	/	11/15(ai12HV)	/	15/18(ai15HV)	/	15/18(ai15HV)
X-axis servo motor	kW	5.5 (aiS40)x2		5.5 (aiS40)x2		5.5 (aiS40)x2		5.5 (aiS40)x2		5.5 (aiS40)x2		5.5 (aiS40)x2		5.5 (aiS40)x2	
Z-axis servo motor	kW	5.5 (aiS40)x2		5.5 (aiS40)x2		5.5 (aiS40)x2		5.5 (aiS40)x2		5.5 (aiS40)x2		5.5 (aiS40)x2		5.5 (aiS40)x2	
CF-axis servo motor	kW	/	5.5 (aiS30)	/	5.5 (aiS40)	/	5.5 (aiS40)	/	5.5 (aiS40)	/	5.5 (aiS40)	/	5.5 (aiS40)	/	5.5 (aiS40)
Coolant pump	kW	3		3		3		3		3		3		3	
Power capacity	KVA	125	150	125	150	125	150	135	170	150	195	165	215	165	215
Tank capacity															
Hydraulic tank	L	130+60		130+60		130+60		130+60		130+60		130+60		130+60	
Coolant tank	L	550		900		1100		2000		2500		2500		2800	
Lubrication tank	L	4.6		4.6		4.6		4.6+8		4.6+8		4.6+8		4.6+8	
Machine dimension															
Floor dimension	mm	5850 x 5000		6090 x 4660		7110 x 5080		11000 x 7000		12500 x 8500		12500 x 8500		13000 x 10500	
Machine height	mm	5300	5300	6450	6450	6550	6550	7400	7400	7400	7400	7400	7400	7800	7800
Machine weight	kg	42000	42500	54000	55000	60500	61500	77000	82000	97000	102000	107000	112000	132000	137000

※Specification is subject to change without prior notice

Optional accessories



AAC-Automatic robotic tool changer



AAC-Automatic attachment changer

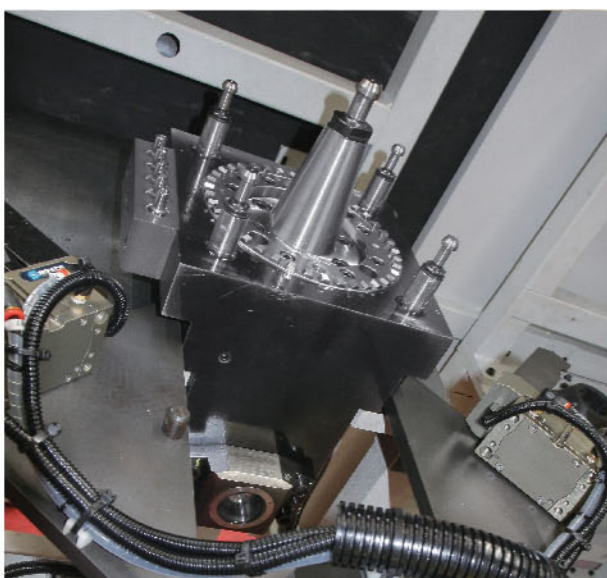

BT50 turning tool holder with 4 pull studs

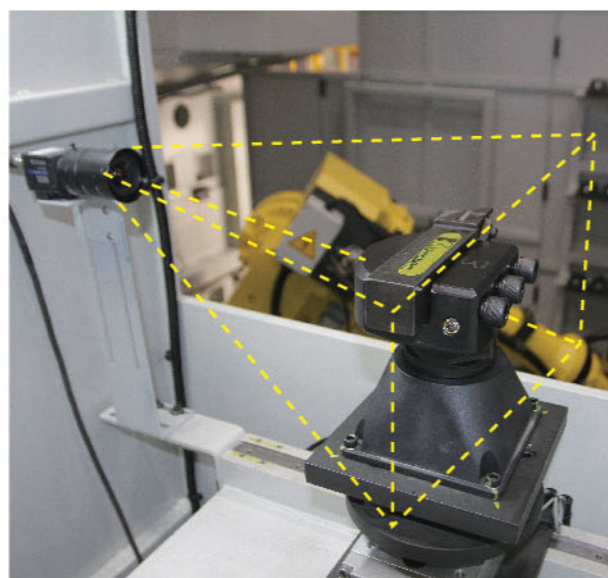

Tool identification system



Tool management system



Tool magazine for 32, 48, 60 tool position

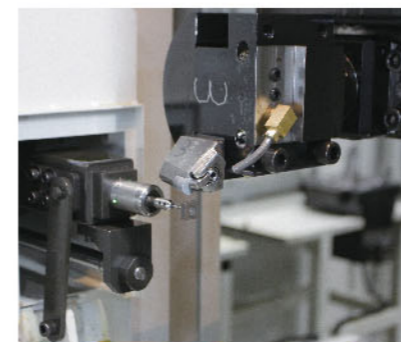

Tool presetter



Capto tool



Side door opening



APC-Automatic pallet changer



Full enclosure guarding

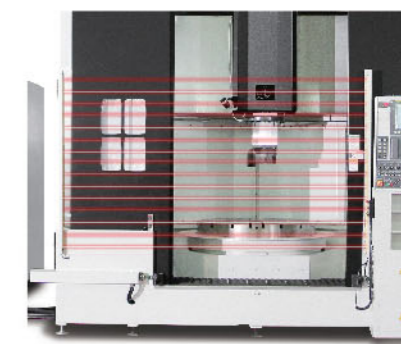

Light curtain & Auto door

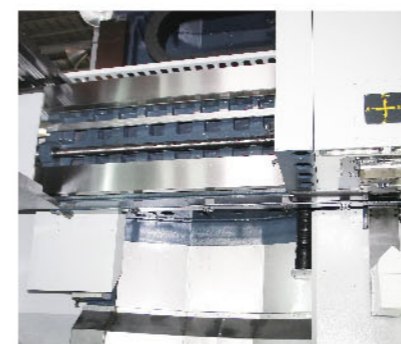

Special way cover design



Spin window

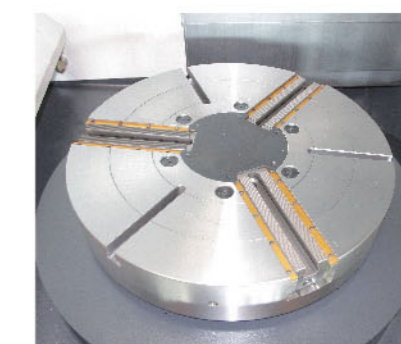

3 jaws/4 jaws/6 jaws hydraulic chuck

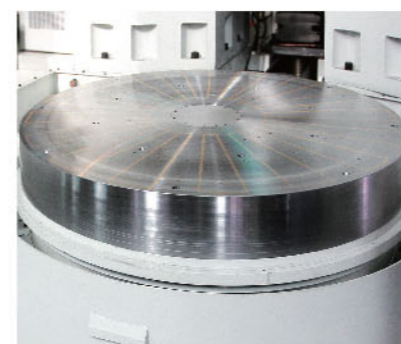

Magnetic chuck



SIEMENS 840 D controller



Pendant / moveable type control

Optional accessories



Hydraulic foot platform

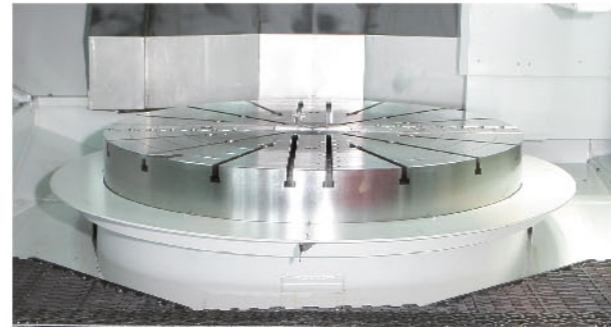

Big slope guarding-Better chip disposal



Machine monitoring system

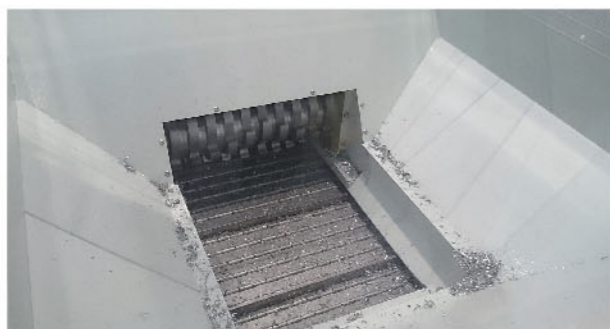

Chip crusher



Coolant through tooling 12/20/60/ bar



X/Z axis linear scales



chips briquetting press



Oil skimmer



Operator's platform extension



Oil mist collector



Paper filter



Grinding attachment

Standard Accessories

- FANUC controller
- 4 jaws manual chuck
VTL1000/1200/1600/2000 series
- 8 jaws manual chuck
VTL2500/3000/3500/4000/4500 series
- 12 positions tool magazine
-VTL1000-2500 ATC series
- 16 positions tool magazine
-VTL1000-2500 ATC+C
&VTL3000-4500 series
- Dual speed gearbox
- Pressure relief automatic
lubrication system
- Chip conveyor and chip bucket
- Air conditioner for electrical cabinet
- Coolant unit
- Signal tower light (3 stage)
- Hydraulic unit
- Square guarding
- Working lamp
- Tool box with tools

Optional Accessories

- SIEMENS 840 D controller
- Tool magazine for 24, 32, 48,
70 tool position
- Coolant through spindle
12/20/70 bar
- Pendant/moveable type control
- 3 jaws/4 jaws/6 jaws hydraulic chuck
- Tool presetter
- Work piece probe
- X/Z axis linear scales
- Paper filter
- Oil mist collector
- Oil skimmer
- Coolant chiller
- Machine monitoring system
- Full enclosure guarding
- Magnetic chuck
- Grinding attachment
- Transformer
- Automatic pallet changer