



# You Ji Machine Industrial Company Limited

## Company information

Tel: 886 - 7 - 695 - 2669  
Fax: 886 - 7 - 695 - 3301  
Email: youji@ms15.hinet.net  
No.92, Huanqiu Rd., Zhuyuan Vil., Luzhu Dist.,  
Kaohsiung City 82142, Taiwan



## Business Scope

- CNC vertical turning center
- CNC horizontal turning center
- Vertical/Horizontal machining center
- CNC inverted spindle lathe
- NC special purpose machine
- Automatic production line



[www.youji.com](http://www.youji.com)



Pinchi-10108(E)

005



Innovation

Technology

# Solutions

Quality

Service

You Ji Machine Industrial  
CNC Vertical Turning Center **VTH Series**



# Vertical Turning Center



## **Leader of Vertical Turning Center**

You Ji's cutting-edge technology is the result of outstanding machine tools





Machine Tool  
Industry Pioneer



## About You Ji

Since its establishment, You Ji has been playing a leading role in the machine tool industry as a pioneer in quality, technology and services. Setting customer satisfaction and sustainable operations as major goals, You Ji applies its execution prowess in innovative R&D and efficiency management to create niches for customers, shareholders, employees and society as a whole. With the spirit of “integrity, responsibility and innovation”, You Ji lays a solid foundation in quality management, equipment management and material management.

With over 30 years of experience, You Ji has a professional R&D design team offering customized integrated solutions to meet individual customers’ needs, and excellent after-sales service and management, enabling us to establish lasting relationships with customers. As the first and largest Taiwanese vertical lathe manufacturer to attain European C.E and EMC certifications for sales in the European and US markets, You Ji currently boasts the most complete series of vertical turning lathes in the world with lathe chuck diameters ranging from  $\phi 200$  to  $\phi 8000$  mm. We conduct technology exchange with large manufacturers in other advanced countries and continuously upgrade our technology to enhance our core technical capabilities and provide customers with better, faster, and more comprehensive services.

### Services

You Ji is a global leader in machine tools with a sales network spanning the globe, offering a wide range of integrated technologies and services and providing speedy solutions to different markets.

### Design

R&D and design of You Ji’s products are market-oriented and customer demand-based. Edge-cutting advanced technology is developed and utilized to manufacture products of high quality.

### Production

With enhanced work efficiency and product quality that meet ISO-9001 standards and the reinforced, smooth and standardized production process, each machine is made according to the strictest and highest quality standards.

### Sales

You Ji boasts a complete product line that encompasses lathes, milling machines, and specialized machines to satisfy diversified industrial production and manufacturing needs.



High loading weight  
for work table



Select  
high grade  
rigid  
materials

### High rigidity construction for high table loads.

The thick work table can bear super huge work-pieces. 250mm super thickness can support large work-pieces, redefining the carrying and cutting performance of vertical lathes.

### High rigidity box type structure design

VTH series parts are made of Meehanite cast iron with a symmetrical box type structure. Finite element analysis (FEA) is conducted to achieve optimized design. Thick ribbed slab and multi-ribbed slab designs can minimize thermal deformation, affording optimum rigidity to the machine, and the studs are detachable, making delivery more convenient and reducing delivery costs.



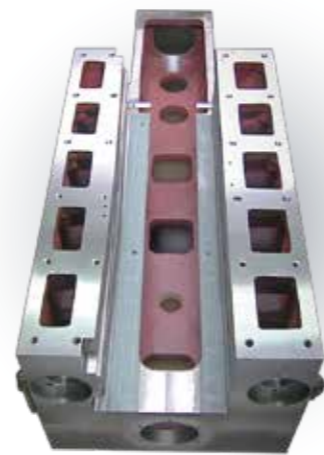

## Hydrostatic bearing



## Hand scraping for precision aesthetics

A high precision vertical turning lathe is not only the combination of technology and algorithms but also the professional experience of You Ji engineers accumulated over years. The strength at each single point guarantees a high precision and outstanding performance vertical turning lathe.

## Vibration resistant pressure-reducing streamline design sets new precision milestone

The vertical lathe combines the latest German hydrostatic and oil-film bearing technology. With full hydrostatic features, both the axial carrying capacity and radial precision achieve optimal stability. It is particularly suitable for processing ultra large and ultra heavy work pieces, with a maximum weight capacity of up to 300 tons (VTH8000).

The volume, pressure, and temperature of hydraulic oil for the hydrostatic bearing are regulated through automatic control, and no manual adjustment is required upon weight change. Both the uninterruptible power supply mechanism for the hydrostatic bearing and the control over mechanical thermal displacement are of special protective design to maintain processing precision and stability of the machine.



Hydrostatic bearing features high vibration absorption and high rigidity, this design is superior to a roller bearing.

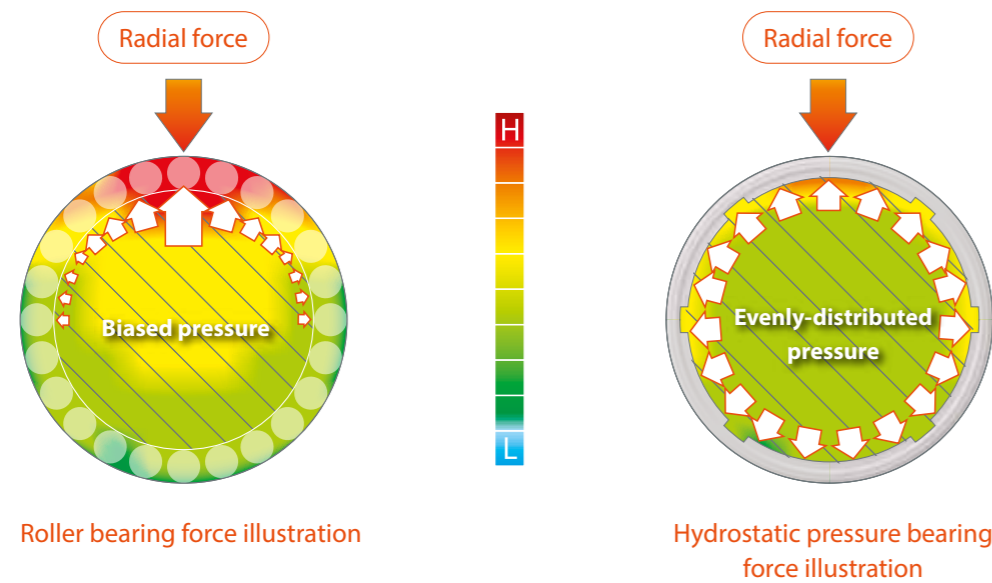

Hydrostatic oil film bearing features high vibration absorption and high rigidity so that delivers the best performance for hard turning of large size bearing. Surface roughness is similar like the ground level quality, and this design is superior to a roller bearing and semi-hydrostatic type machine.

Hydrostatic bearing features friction-free, less loss spindle output, coupled with dual-drive spindle system that provides high torque and horsepower at low speed for energy saving and heavy cutting.

## Cs axis bilateral automatic positioning – The pursuit of precise performance

Special dual-drive spindle system with Cs axis indexing mechanism enhances spindle output torque and eliminates mechanical transmission backlash, the repeatability of indexing accuracy of the Cs axis is 5 seconds, positioning accuracy 10 seconds, delivering the best complex turning and machining solutions.

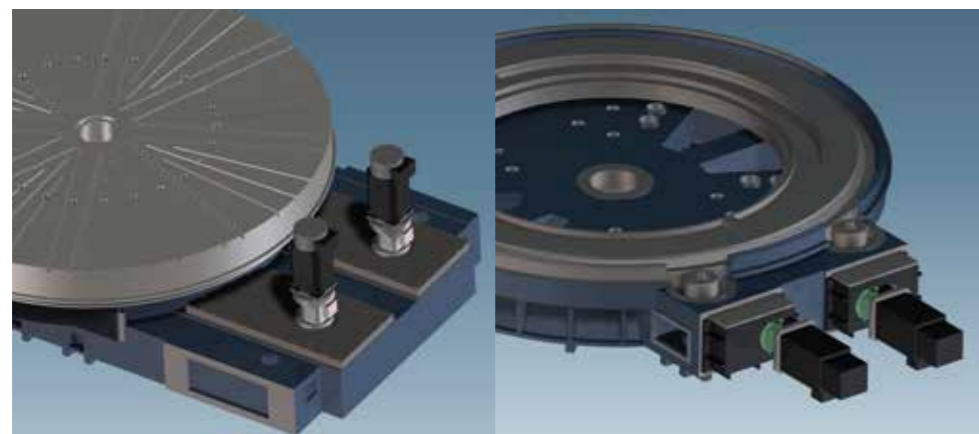

VTH 3000 - VTH 5000

VTH 6000 - VTH 8000

The Cs axial applies Siemens 1PH7 high-performance spindle motor, providing maximum cutting and rotating axial momentum with maximum response through double-spindle motor joint drive and synchronized coupling control.

## 1PH7 ◀ Highly reliable spindle motor with large power output

1PH7 is a series of high-performance non-synchronous servo-motors, featuring clear-cut lengths and dimensions, integrated terminal box design, high power density, and a high rotation speed of up to 9000 rounds (or 12000 rounds, optional). Continuous full-torque output is possible even when idle. The ultra-full momentum is the optimal power source for a spindle or a counter spindle of machine tools to enable extraordinary cutting process performance.



### Highlights

- High power density at minimal dimensions
- High degree of protection
- Wide range of speeds
- Torque at zero speed
- High reliability
- Maintenance-free
- Bearing-supported arbor for high cantilever load
- High precision at low speeds
- High-precision encoding system integration for speed control
- Two signal line options available - with a rotary joint or DRIVE-CLiQ
- Connect with power lines through terminal box
- Detection of motor coil temperature through KTY 84
- Different motor cooling methods

### Output range

- Rated power: 3.7-205 kw
- Rated torque: 23.6-1080Nm
- Rated rotation speed: 500-2500rpm

Linear servo drive is accomplished by Siemens high-performance and highly reliable 1FK7 series servo motors which feature precise position control and can easily accommodate large torque.

## 1FK7 ◀ with high dynamic performance for motion control

While applications with low demands of precision and dynamic response are often solved satisfactorily with standard induction motors, specially optimized synchronous motors are needed to successfully implement Motion Control applications. With the motor series 1FK7, Siemens offers a range of synchronous motors designed specifically for the needs of Motion Control applications. Excellent dynamic characteristics, high overload capability, compact design and high durability as well as easy handling are the core characteristics of this motor series. Available in a torque range from 0.18 to 48 Nm, 1FK7 motors are the first choice when it comes to providing easy and cost effective solutions for Motion Control applications.

1FK7 Compact motors offer a high range of performance within the smallest space. Because of their short installation length, they are simply predestined to be installed in tight spaces. Their compactness makes them the standard motor used in torque ranges of between 0.18 and 48 Nm. In doing so, they provide an enormous amount of dynamics to Motion Control shafts – thanks to their high overload capacity. Motors are available in a range of 22 types with seven shaft heights and rated speeds of up to 6,000 min<sup>-1</sup>.



### Main Features

- Standstill torques of 0.18 - 48Nm
- Rated speeds of up to 6,000 min<sup>-1</sup>
- Different inertia versions: Standards, High Dynamic, High Inertia
- Up to triple overload capacity
- Compact design
- High protection type IP64 or IP65 (wave passage IP67)
- With a choice of absolute encoder, incremental encoder, resolver
- System interface DRIVE-CLiQ to SINAMICS S110 or SINAMICS S120 with electronic rating plate
- Can be supplied optionally with planetary gears, frontal or bevel gears

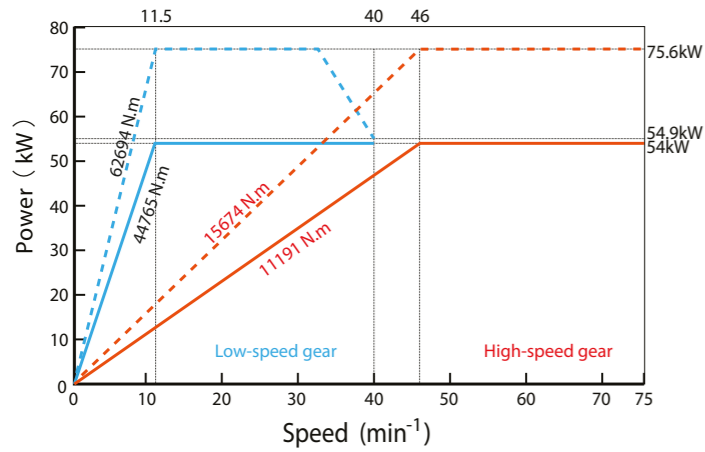

(Motor: Siemens 1PH7186-2QE) High-speed ratio: 27.15 Low-speed ratio: 108.6

VTH3000/3500 ATC

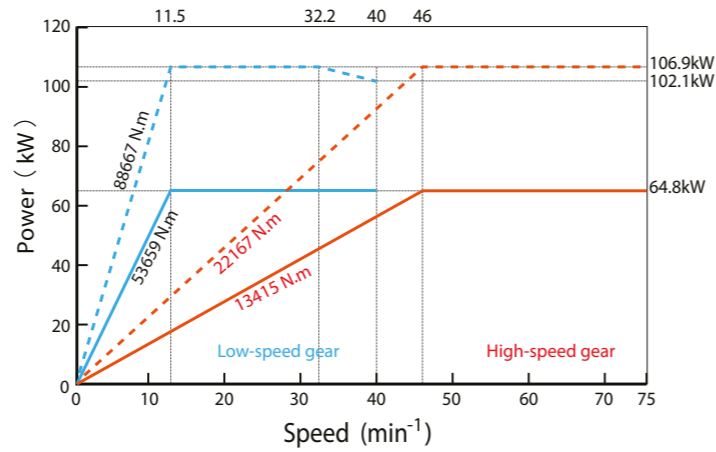

(Motor: Siemens 1PH7184-2QE) x2 High-speed ratio: 27.15 Low-speed ratio: 108.6

VTH3000/3500 ATC+C

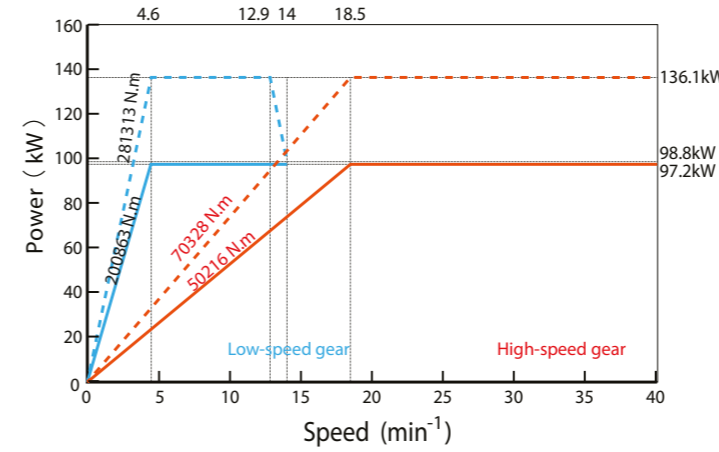

(Motor: Siemens 1PH7186-2QE) x2 High-speed ratio: 67.68 Low-speed ratio: 270.72

VTH5000 ATC  
VTH5000 ATC+C

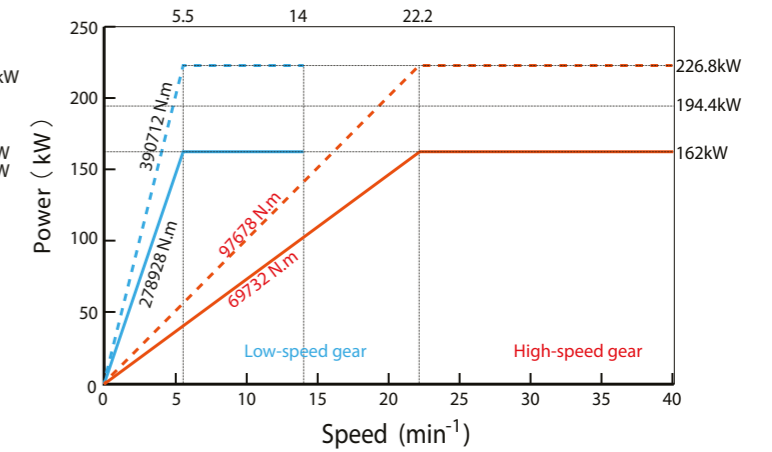

(Motor: Siemens 1PH7224-2QE) x2 High-speed ratio: 67.68 Low-speed ratio: 270.72

VTH5000 ATC-2R  
VTH5000 ATC+C-2R

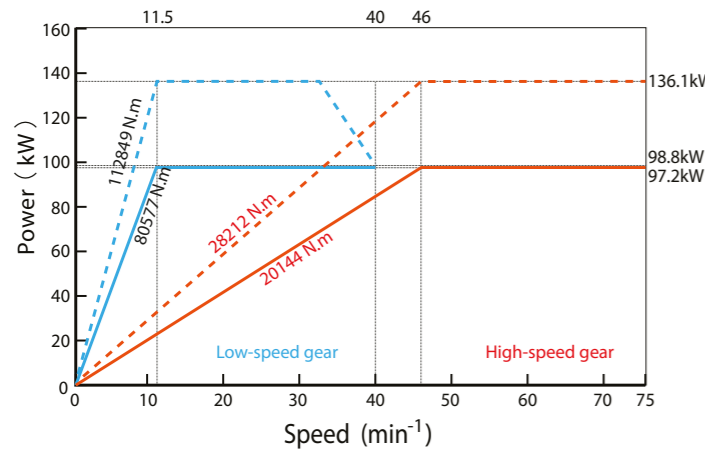

(Motor: Siemens 1PH7186-2QE) x2 High-speed ratio: 27.15 Low-speed ratio: 108.6

VTH3000/3500 ATC-2R  
VTH3000/3500 ATC+C-2R

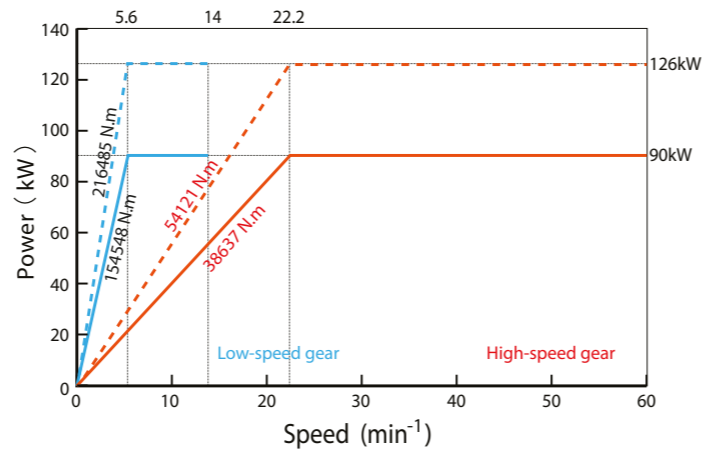

(Motor: Siemens 1PH7224-2QE) High-speed ratio: 67.5 Low-speed ratio: 270

VTH4000/4500 ATC

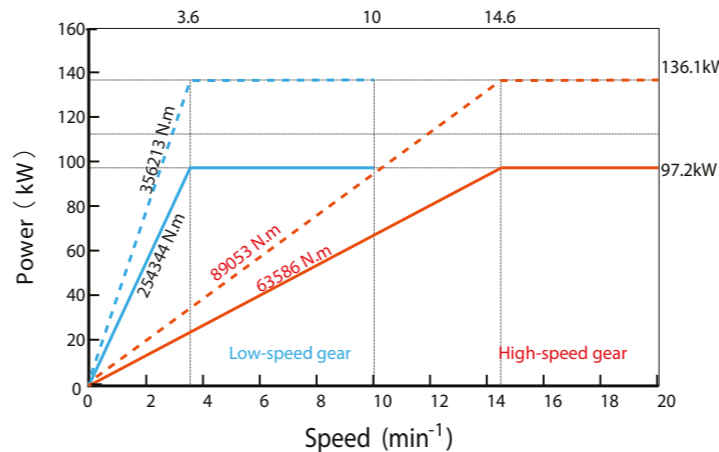

(Motor: Siemens 1PH7186-2QE) x2 High-speed ratio: 85.7 Low-speed ratio: 342.8

VTH6000 ATC  
VTH6000 ATC+C

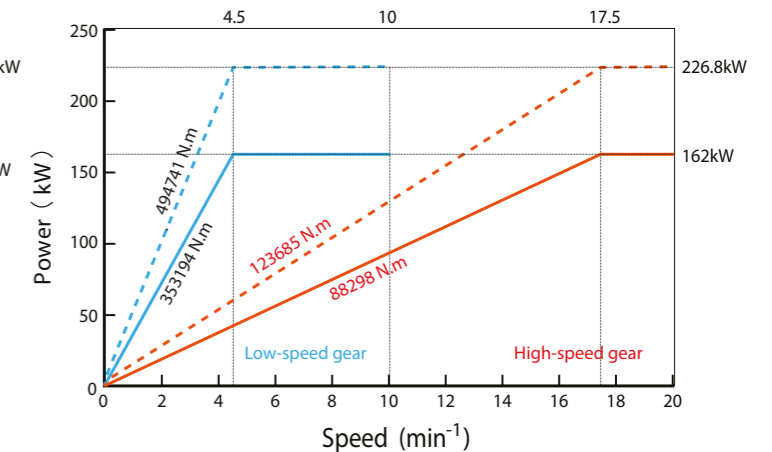

(Motor: Siemens 1PH7224-2QE) x2 High-speed ratio: 85.7 Low-speed ratio: 342.8

VTH6000 ATC-2R  
VTH6000 ATC+C-2R

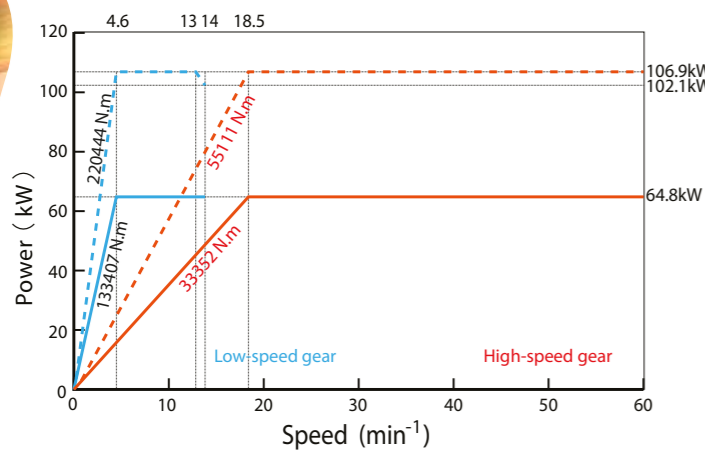

(Motor: Siemens 1PH7184-2QE) x2 High-speed ratio: 67.5 Low-speed ratio: 270

VTH4000/4500 ATC+C

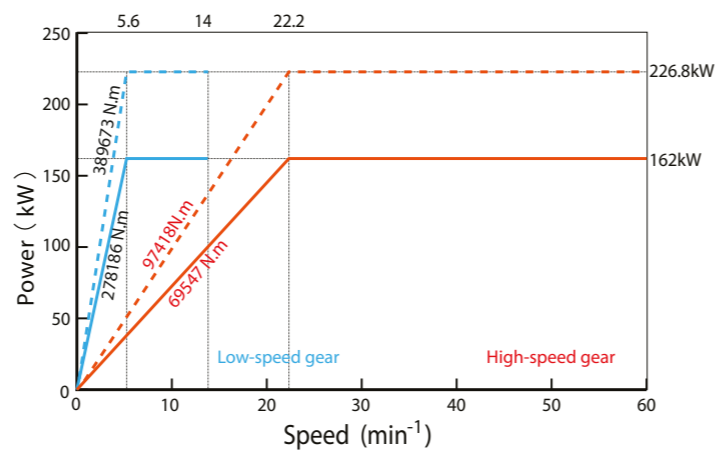

(Motor: Siemens 1PH7224-2QE) x2 High-speed ratio: 67.5 Low-speed ratio: 270

VTH4000/4500 ATC-2R  
VTH4000/4500 ATC+C-2R

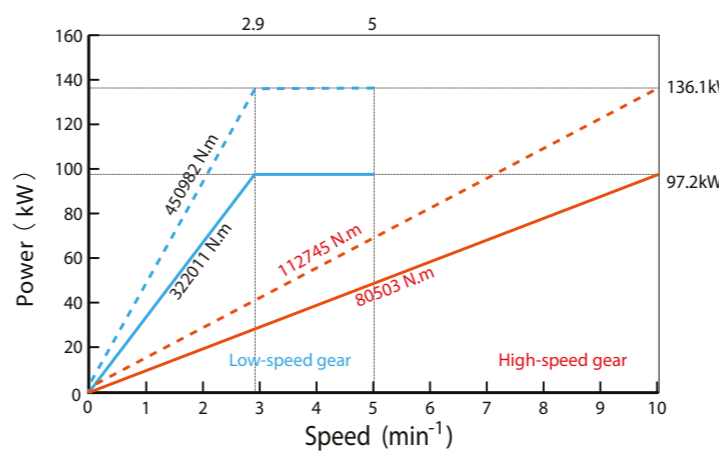

(Motor: Siemens 1PH7186-2QE) x2 High-speed ratio: 108.5 Low-speed ratio: 434

VTH7000/8000 ATC  
VTH7000/8000 ATC+C

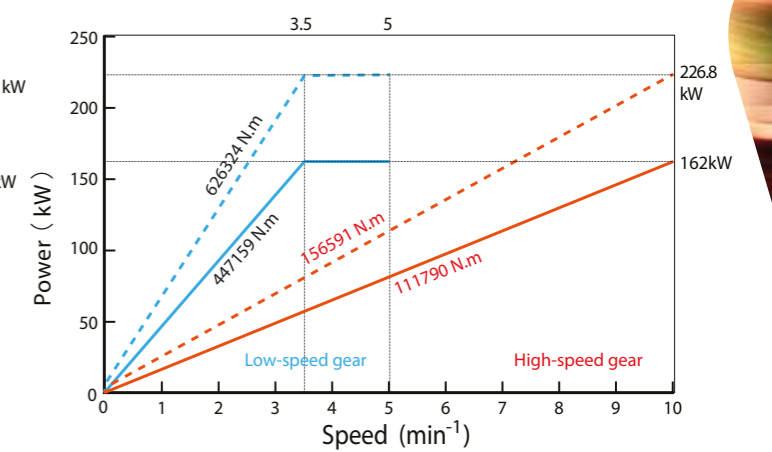

(Motor: Siemens 1PH7224-2QE) x2 High-speed ratio: 108.5 Low-speed ratio: 434

VTH7000/8000 ATC-2R  
VTH7000/8000 ATC+C-2R





German equipment with high-performance drive

## Complex Machining

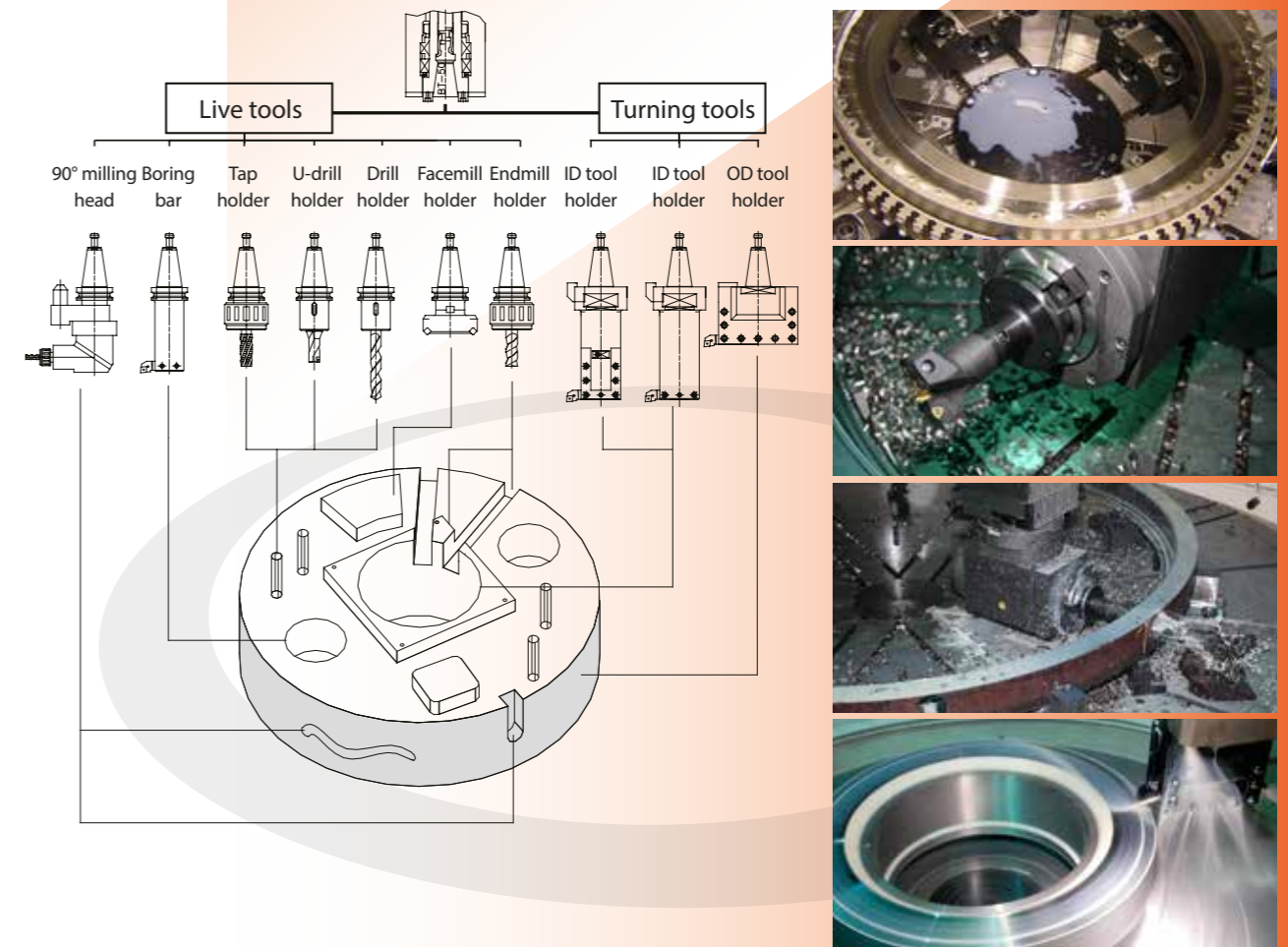

## Live spindle with high-performance drive

The live spindle motor, coupled with the dual speed gearbox is located on top of the RAM, driving the live spindle via drive shaft. The use of the dual speed gearbox on the live spindle enables high torque output. The model is mainly paired with Siemens high-performance spindle motors 1PH7131 and 1PH7137. The 1PH7 spindle motor has excellent output-volume ratio. Installed in a flange, the ultra-large contact surface serves as the auxiliary force for vibration dampening, and also features steady and saturated momentum. The motor comes in rated power of 11 and 17kw.

It is a perfect match to the cutting load borne by the power live spindle, enabling the machine with multiple processing techniques such as face milling, end milling, boring and tapping, high torque, and high rotating speeds.

## Siemens motor 1PH7131/1PH7137 (live spindle motor)

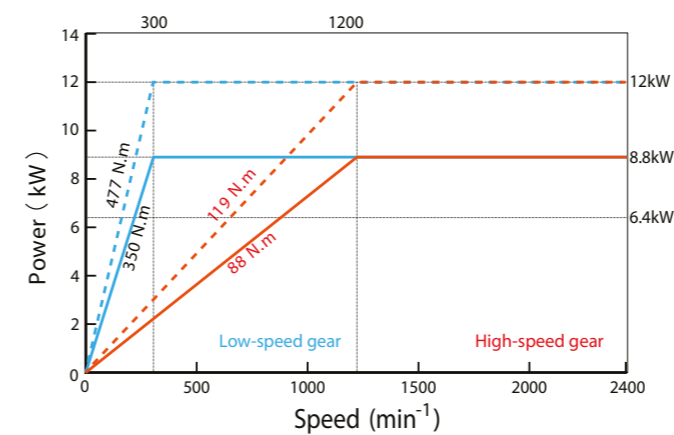

(Motor: Siemens 1PH7131-2QF) High-speed ratio: 1.25 Low-speed ratio: 5

VTH3000/3500 ATC+C series

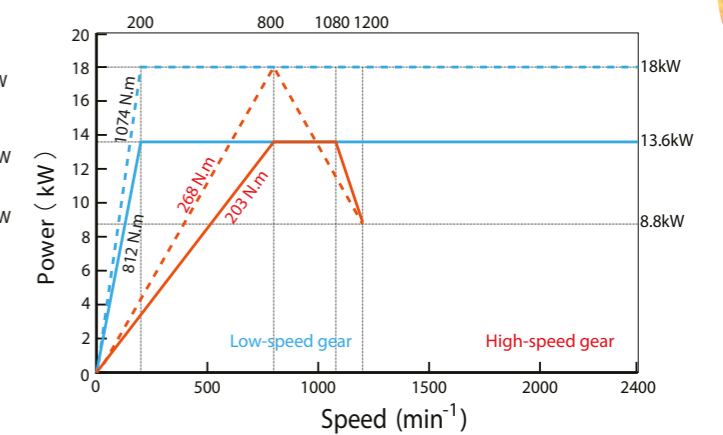

(Motor: Siemens 1PH7137-2QD) High-speed ratio: 1.25 Low-speed ratio: 5

VTH4000/8000 ATC+C series





German equipment:  
SINUMERIK 840D sl

## The ultimate in accuracy

SINUMERIK and SINAMICS are equipped with 80-bit NANO<sup>FP</sup> Accuracy. As a result, accuracy of well under a nanometer can be achieved. This precision is not just available for closed-loop position control but also for current regulation and closed loop speed control, as well as within the context of drive sensor evaluation.

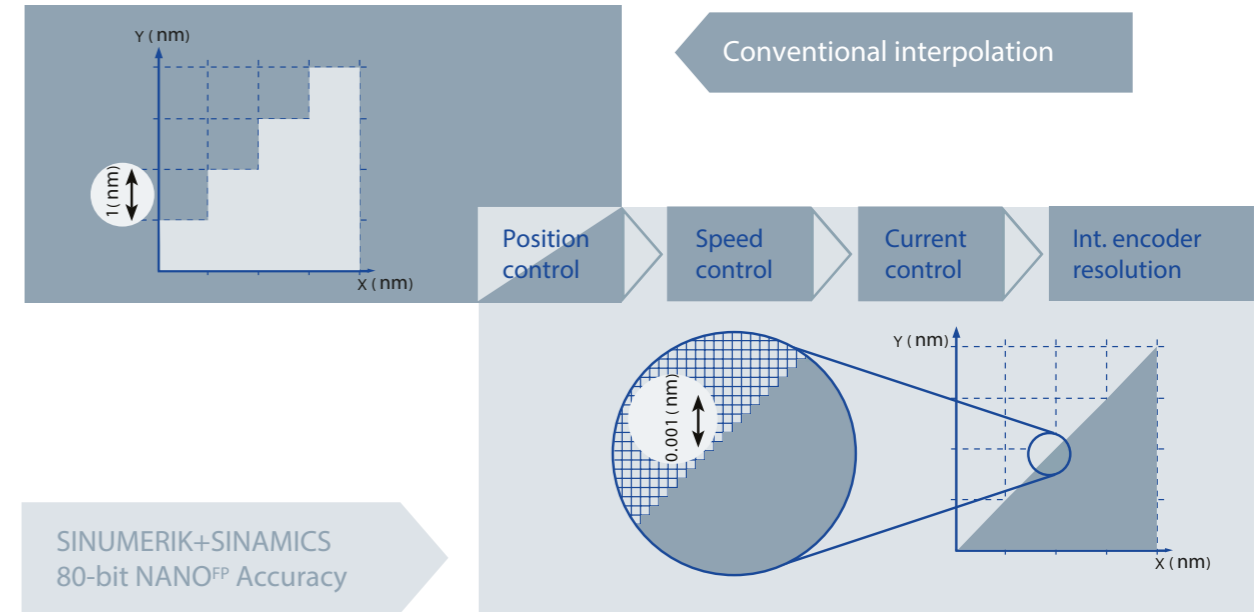

## Innovative machining for complete machining Milling and Turning

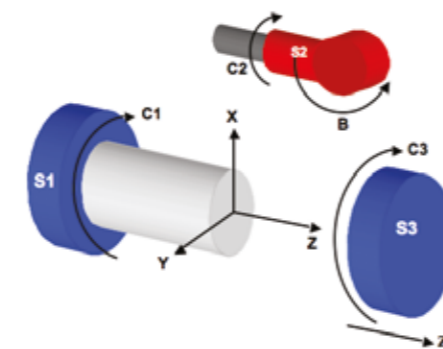

### Turning-milling

- Machines with driven tools, Y axis, B axis and counter spindle use the complete milling functionality including plane and tool swiveling
- Use milling cycle support
- Convenient swiveling of turning tools
- 3D simulation also for milling

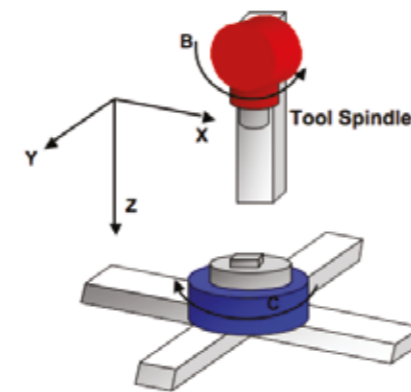

### Milling-turning

- Machines with B axis and rotary table in specific kinematics
- Machines with A axis in specific kinematics
- Replacement of C axis / A axis and spindle for rotary mode (application-specific by the OEM)
- Use of rotary functions (technology and turning tools, etc. in the programGuide and G code methods)
- Use turning cycle support

ISO-Code with predefined cycles

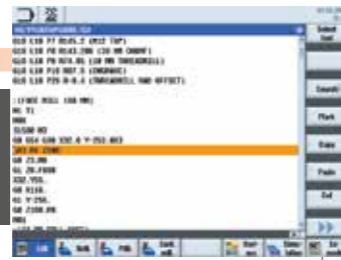

Designed for maximal ISO-Code compatibility

DIN & SINUMERIK high-level language with programGUIDE

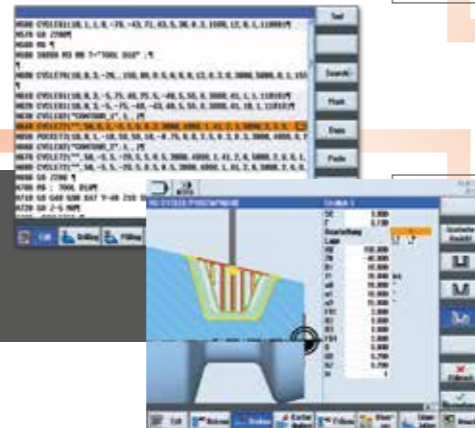

Designed for maximal flexibility and shortest machining times

ShopMill/ShopTurn work step programming

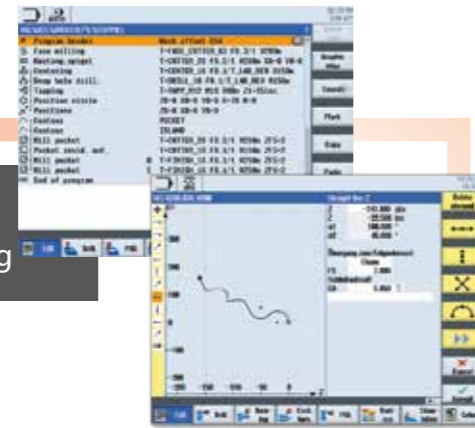

Designed for shortest programming times

ProgramSYNC

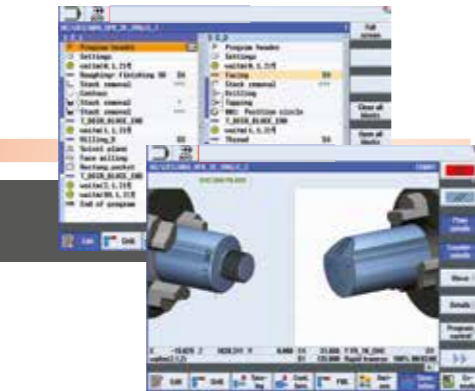

Designed for increased productivity for multi-channel machines

The SINUMERIK high-level language with programGUIDE was developed for maximum flexibility and short development times – and it is perfect for medium to large batch sizes. programGUIDE ensures an extremely high degree of productivity and programming flexibility, combined with innovative technology and processing cycles.

- CNC language with high-level programming commands
- programGUIDE with graphical cycle support images including tooltip (context-based short information)
- Online ISO dialect Interpreter available

## ShopMill/ShopTurn workstep programming

ShopMill and ShopTurn workstep programming is the tailor made programming solution for the production of individual parts and small batch sizes. In addition to programGUIDE, ShopMill/ShopTurn also offer unique step sequence programming for extremely short programming times.

- Clear display of processing steps without G-code knowledge
- Simple interlinking of technology functions with geometric elements
- Dynamic display of the workpiece during programming

## Efficient programming for multi-channel machines

SINUMERIK supports multi-tasking machines when processing workpieces in one process step. New functions for complete processing are already being prepared.

## A user-friendly solution for multi-channel machines

SINUMERIK's numerous functions for easy operation include display via the dual editor, which shows a two-channel basic configuration. In milling processes, the second channel can be used to control and visualize handling modules or tool changes, for example – for even greater flexibility and cost-efficiency in production. With the programSYNC option, multi-channel processes can be synchronized quickly and easily. The simulation allows excellent visualization of multi-channel processing via SINUMERIK 840D sl. This allows multi-channel processes to be programmed with even greater efficiency:

- Create part program structures
- Fill individual process steps (blocks)
- Simulate part programs
- Apply part programs (by channel or by spindle)

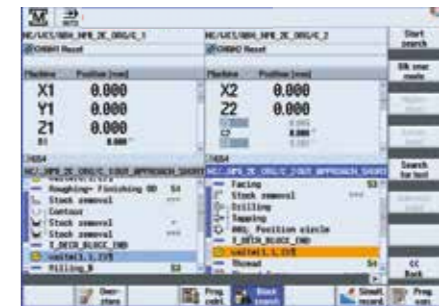

Dual Channel Machine Display

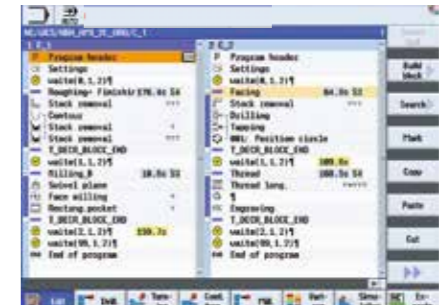

Dual Program & Sequence Editor

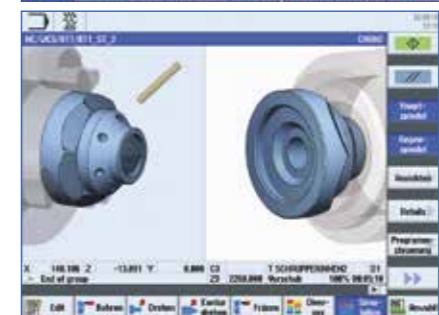

Dual Channel Program Simulation



Multi-Channel Program Control





Automatic variety tool magazine

## Tool management: Everything at a glance, everything under control.

Tool management made easy for higher production and easy operation

SINUMERIK offers a modern and clear system of tool management. The tools list has a configurable display and can be intuitively operated and displayed using context dependent functions and self-explanatory icons – for efficient management of tool data.

- Intuitive operation through graphic tool type symbols
- Tool and magazine data are displayed on one screen
- Tool name in plaintext
- Tool life monitoring by part count and cutting time are supported
- Easy replacement tool and big tool management and setup on the screen without additional effort

The screenshot displays two main windows. The top window, titled 'TOA 2 Tool list', shows a table of tool data with columns for location, type, name, and various dimensions. The bottom window, titled 'Magazin', shows a list of tools in a magazine with columns for location, type, name, and status.

Loc.	Type	Tool name	ST	D	Length X	Length Z	Radius	Loc. leng	Rev_12	Tool measure
1		ROUGHING_TOOL12	1	1	0.000	0.000	0.000	93.0 55	11.0	
2		FINISHING_TOOL_20	1	1	0.000	0.000	0.000	93.0 55	11.0	
3		ROUGHING_13	1	1	0.000	0.000	0.000	93.0 55	11.0	
4		THREADING_TOOL1	1	1	0.000	0.000	0.000			Edges
5		DRILL_5	1	1	0.000	0.000	5.000		118.0	
6		BORING BAR_20	1	1	0.000	0.000	20.000			
7		SOLID DRILL_10	1	1	0.000	0.000	10.000			
8		PLUNGE CUTTER_4	1	1	0.000	0.200	4.000	4.000	0.0	
9		ROTARY_DRILL1	1	1	0.000	0.000	0.000	35.00		Unload
10		TAP_M16	1	1	0.000	0.000	6.000	0.800		Delete tool
11										Magazine selection
12										

Platz	Typ	Werkzeugname	ST	D	G	Mag.-platztyp	Werkz.-platztyp	ü	P
		SCHRUPPER_80	1	1		0	1		
1	+	MESSERKOPF_63	1	1		1	1		
2		STECHE_3	1	1		1	1		
3	+	BOHRER_10.2	1	1		1	1		
4		ZENTRIERER_20	1	1		1	1		
5	+	GEWINDE_M12	1	1		1	1		
6	+	FRAESER_10	1	1					
7	+	GEWINDEBOHRER_M11	1	1		1	1		
8	+	BOHRER_8.5	1	1		1	1		
9		BOHRER-8	1	1		1	1		
10	+	Fraeser_32	1	1		1	1		
11	+	PLANFRAESER	1	1		1	1		
12	+	FRAESER_16	1	1		1	1		
13		FRAESER_8	1	1		1	1		
14	+	FRAESER_6	1	1		1	1		
15	+	ZENTRIERER_12	1	1		1	1		
16		FRAESER6	1	1		1	1		

## Automatic tool changer ATC

The user-friendly and easily operated chain-type tool magazine houses 16 tools for quick bilateral selection. Chain-slat tool magazines with a 32, 48, or 60-inch tool path are also available.



## Diagram of Working Table

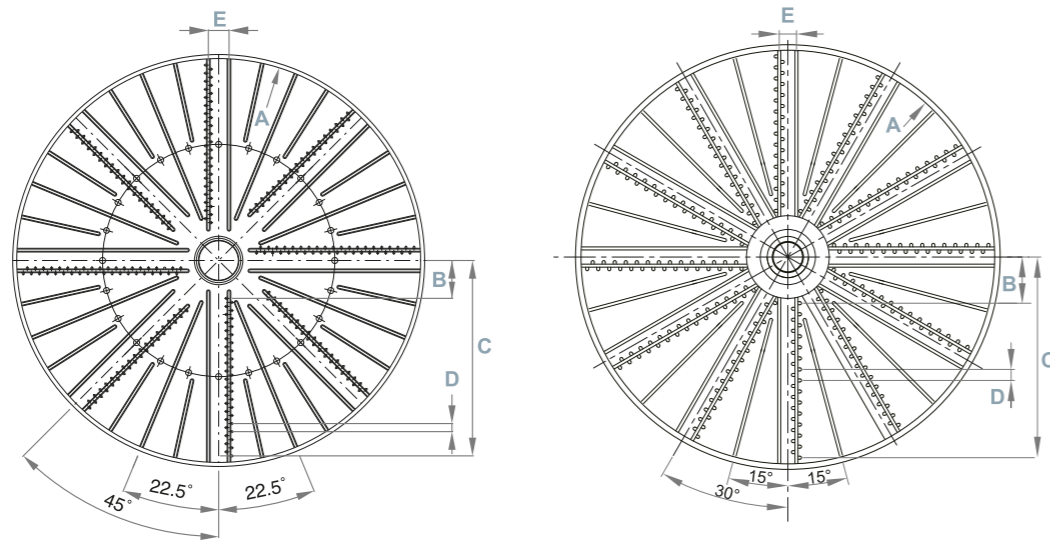

Series	A	B	C	D	E
VTH3000	Ø3000	375	1463	80	205
VTH3500	Ø3500	375	1703	80	205
VTH4000	Ø4000	375	1935	80	205
VTH4500	Ø4500	375	2175	80	205
VTH5000	Ø5000	500	2420	80	240

8 Jaws Unit mm

Series	A	B	C	D	E
VTH6000	Ø6000	800	2880	80	240
VTH7000	Ø7000	1325	3405	80	400
VTH8000	Ø8000	1325	3885	80	400

12 Jaws Unit mm

## Dimension of Chuck Jaws

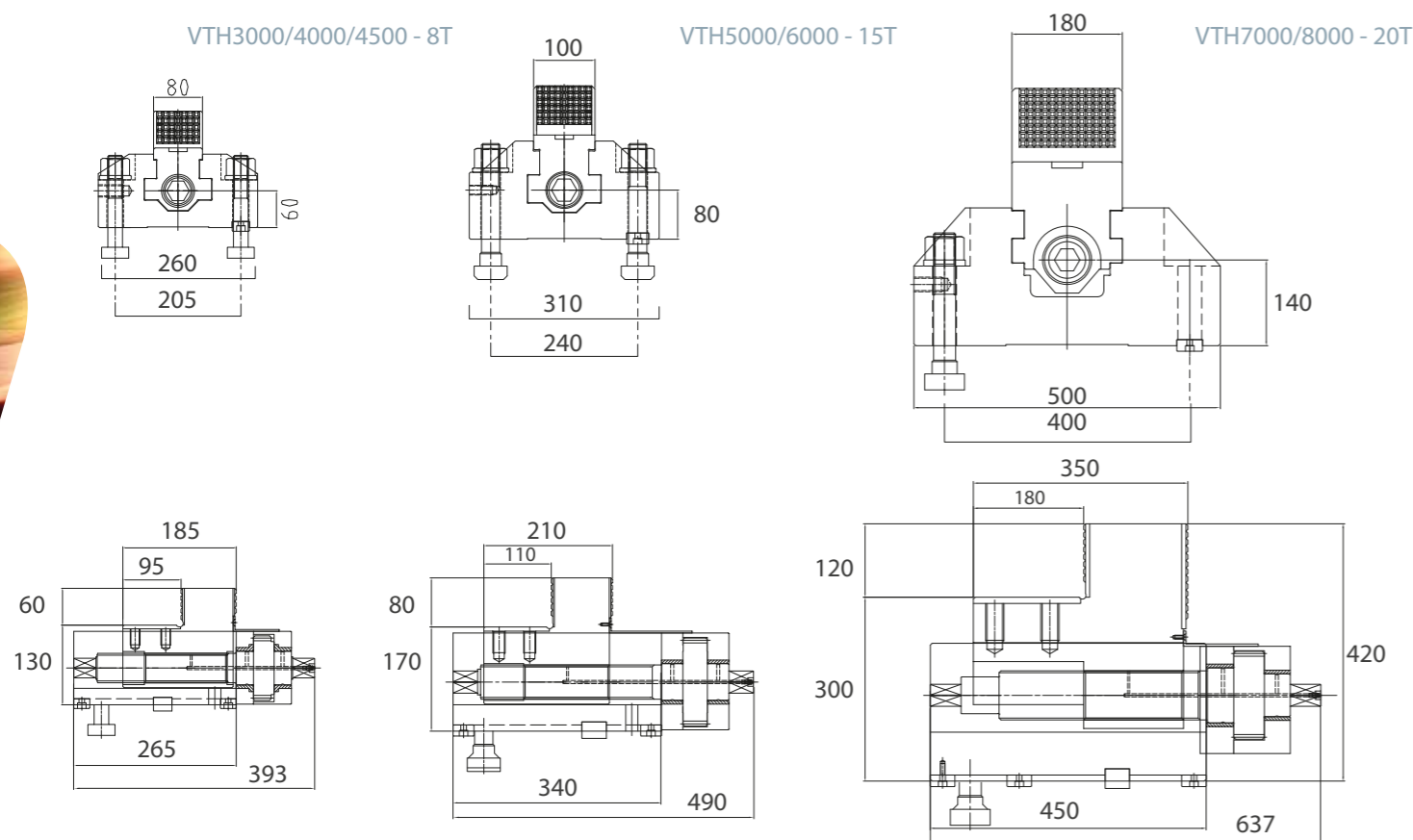

## Inside & outside clamping for Chuck Jaws

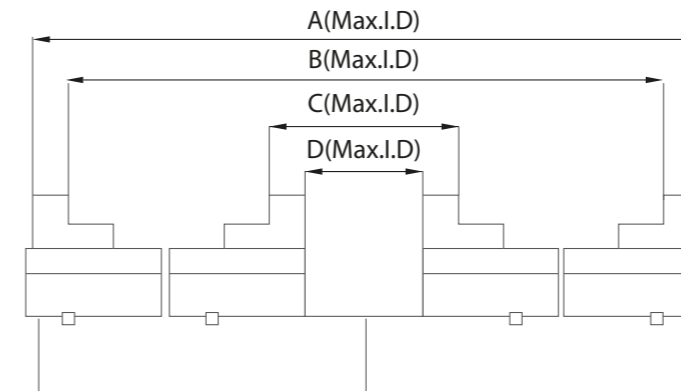

Series	A	B	C	D
VTH3000	2756	2585	1025	845
VTH3500	3425	3065	1025	845
VTH4000	3710	3530	1090	910
VTH4500	4190	4010	1090	910
VTH5000	4700	4500	1200	1000
VTH6000	5600	5400	1600	1400
VTH7000	6550	6200	2750	2400
VTH8000	7500	7200	2750	2400

Unit mm

## Information of RAM Specifications

Series	Standard	Optional Accessories		
VTH3000	A	B	C	D
VTH3000 - I	A	B	C	D
VTH3000 - II	A	B	C	D
VTH3000 - III	A	B	C	D
VTH3500	A	B	C	D
VTH3500 - I	A	B	C	D
VTH3500 - II	A	B	C	D
VTH3500 - III	A	B	C	D
VTH4000	A	B	C	D
VTH4000 - I	A	B	C	D
VTH4000 - II	A	B	C	D
VTH4000 - III	A	B	C	D
VTH4500	A	B	C	D
VTH4500 - I	A	B	C	D
VTH4500 - II	A	B	C	D
VTH4500 - III	A	B	C	D
VTH5000	E	F	G	
VTH5000 - I	E	F	G	
VTH5000 - II	F	G		
VTH5000 - III	F	G		
VTH6000	E	F	G	
VTH6000 - I	E	F	G	
VTH6000 - II	F	G		
VTH6000 - III	F	G		
VTH7000	E	F	G	
VTH7000 - I	F	G		
VTH7000 - II	F	G		
VTH7000 - III	G			
VTH8000	E	F	G	
VTH8000 - I	F	G		
VTH8000 - II	F	G		
VTH8000 - III	G			

## RAM Interference

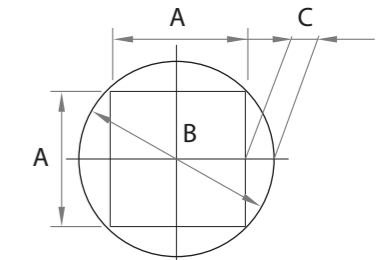

RAM Type	Travel	A	B	C
A-Type				
BT50	1500	250	350	50
B-Type				
BT60	1500	280	400	60
C-Type				
BT50	1800	300	425	62
D-Type				
BT60	1800	300	425	62
E-Type				
BT50 + 4xBT50	1500	350	500	75
F-Type				
BT60 + 4xBT50	2000	400	570	85
G-Type				
BT60 + 4xBT50	2500	400	570	85

Unit mm



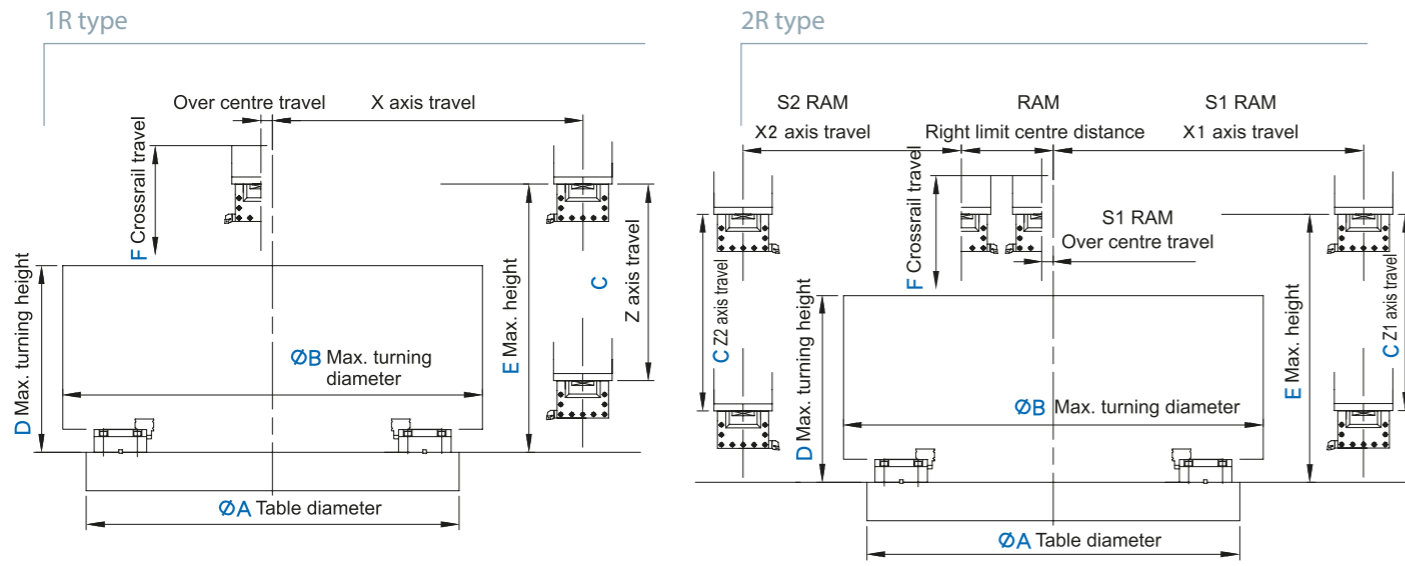

Series	A	B	C	D	E	F
VTH3000 ATC	3000	3300	1500	1600	1929	1200
VTH3000 ATC - I	3000	3300	1500	2200	2529	1400
VTH3000ATC - II	3000	3300	1500	2800	3144	2000
VTH3000ATC - III	3000	3300	1500	3200	3529	2400
VTH3500 ATC	3500	3800	1500	1600	1929	1200
VTH3500 ATC - I	3500	3800	1500	2200	2529	1400
VTH3500ATC - II	3500	3800	1500	2800	3144	2000
VTH3500ATC - III	3500	3800	1500	3200	3529	2400
VTH4000 ATC	4000	4300	1500	1500	1804	1200
VTH4000 ATC - I	4000	4300	1500	2100	2404	1400
VTH4000ATC - II	4000	4300	1500	2700	3019	2000
VTH4000ATC - III	4000	4300	1500	3100	3404	2400
VTH4500 ATC	4500	4800	1500	1500	1804	1200
VTH4500 ATC - I	4500	4800	1500	2100	2404	1400
VTH4500ATC - II	4500	4800	1500	2700	3019	2000
VTH4500ATC - III	4500	4800	1500	3100	3404	2400

Series	A	B	C	D	E	F
VTH5000 ATC	5000	5900	1500	2100	2570	1400
VTH5000 ATC - I	5000	5900	1500	2700	3170	2000
VTH5000ATC - II	5000	5900	2000	3100	3570	2400
VTH5000ATC - III	5000	5900	2000	3500	3970	2800
VTH6000 ATC	6000	6900	1500	2100	2570	1400
VTH6000 ATC - I	6000	6900	1500	2700	3170	2000
VTH6000ATC - II	6000	6900	2000	3100	3570	2400
VTH6000ATC - III	6000	6900	2000	3500	3970	2800
VTH7000 ATC	7000	8500	1500	2600	3075	1600
VTH7000 ATC - I	7000	8500	2000	3400	3875	2400
VTH7000ATC - II	7000	8500	2000	3800	4275	2800
VTH7000ATC - III	7000	8500	2500	5000	5475	4000
VTH8000 ATC	8000	8900	1500	2600	3075	1600
VTH8000 ATC - I	8000	8900	2000	3400	3875	2400
VTH8000ATC - II	8000	8900	2000	3800	4275	2800
VTH8000ATC - III	8000	8900	2500	5000	5475	4000

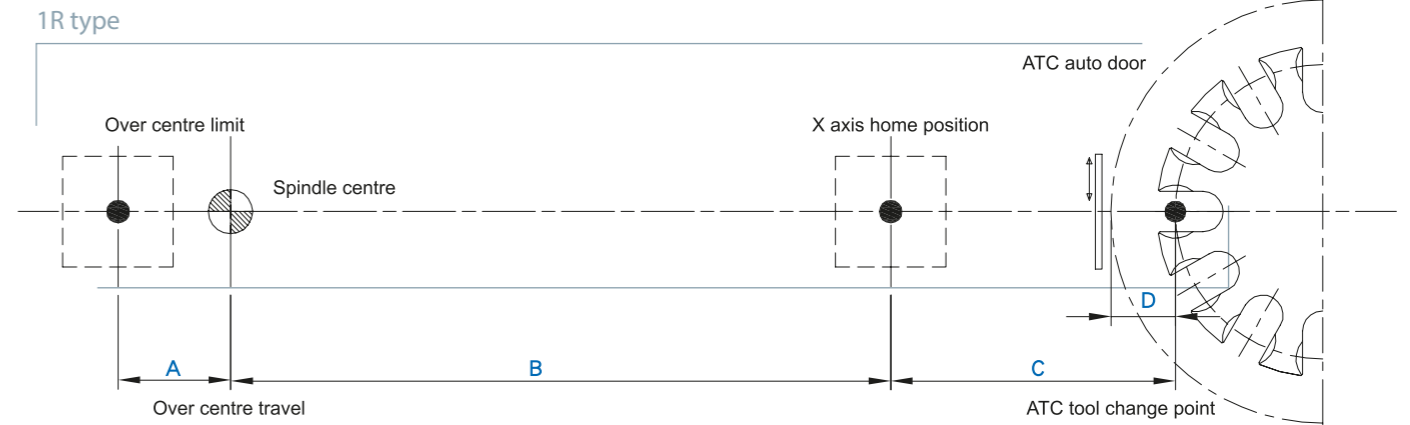

Series	A	B	C	D
VTH3000	1500	1650	600	175
VTH3500	2000	2350	600	175
VTH4000	2000	2350	600	175
VTH4500	2250	2650	600	175

Series	A	B	C	D
VTH5000	2350	3010	850	325
VTH6000	3000	3510	925	325
VTH7000	4300	5050	950	550
VTH8000	4300	5050	950	550

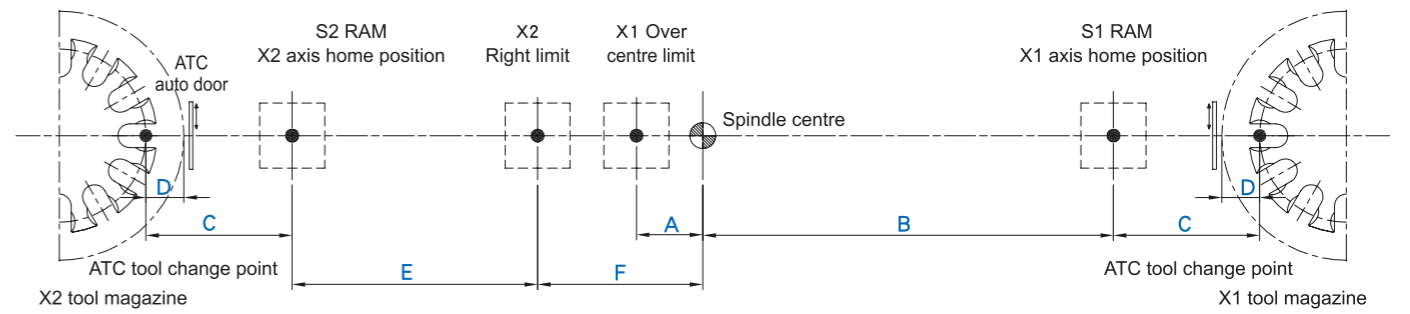

Series	A	B	C	D	E	F
VTH3000 2R	50	1650	600	175	950	700
VTH3500 2R	50	2350	600	175	1650	700
VTH4000 2R	50	2350	600	175	1650	700
VTH4500 2R	50	2650	600	175	1950	700

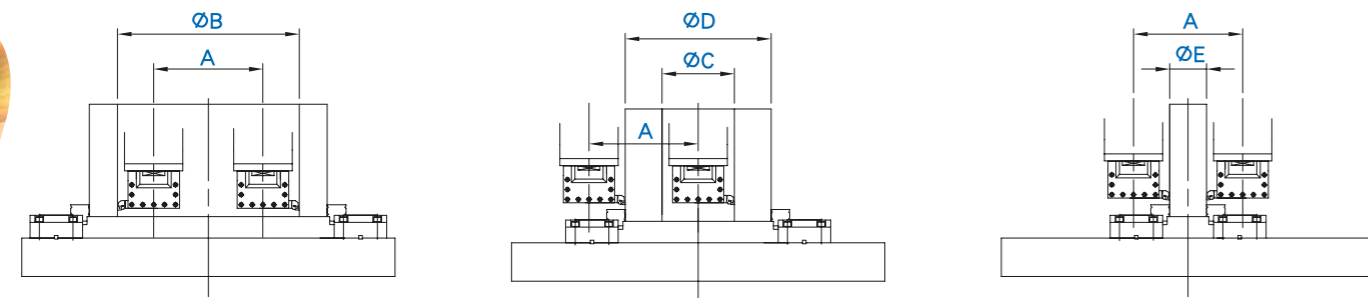

Series	A	B	C	D	E
VTH3000 2R	1400	1700	400	2500	1100
VTH3500 2R	1400	1700	400	2500	1100
VTH4000 2R	1400	1700	400	2500	1100
VTH4500 2R	1400	1700	400	2500	1100

Series	A	B	C	D	E
VTH5000 2R	1900	2430	530	3300	1400
VTH6000 2R	1900	2430	530	3300	1400
VTH7000 2R	2000	2530	530	3470	1470
VTH8000 2R	2000	2530	530	3470	1470

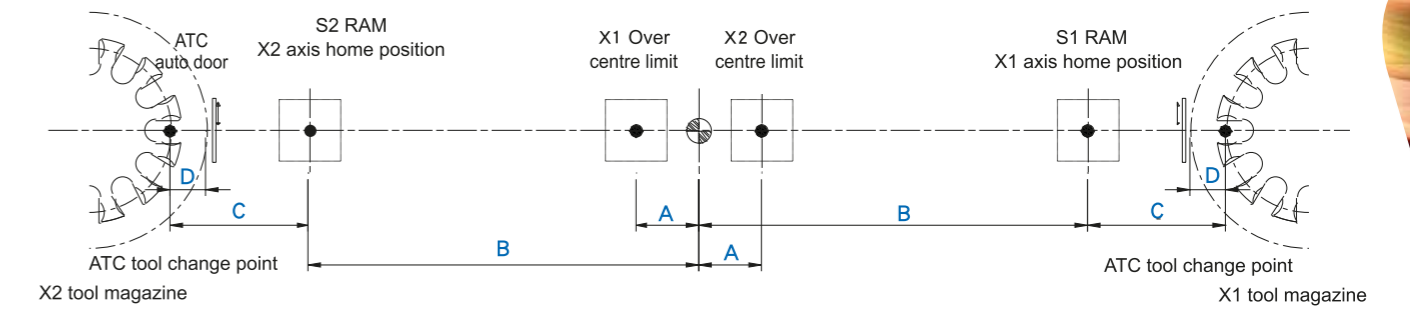

Series	A	B	C	D
VTH5000 2R	250	3010	850	325
VTH6000 2R	250	3510	925	325
VTH7000 2R	250	5050	950	550
VTH8000 2R	250	5050	950	550

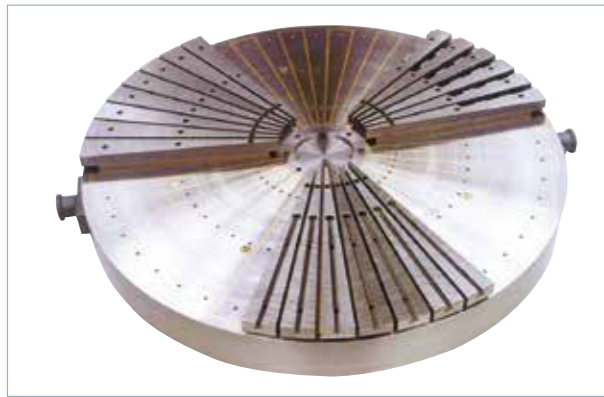

Magnetic chuck

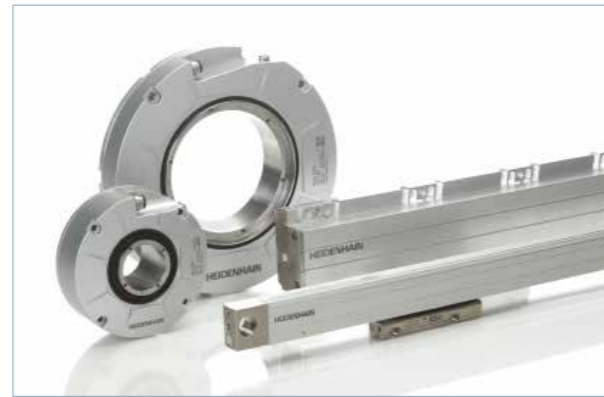

Linear scale



90°milling head



Work piece probe



Coolant chiller



Coolant through spindle system



High pressure pump

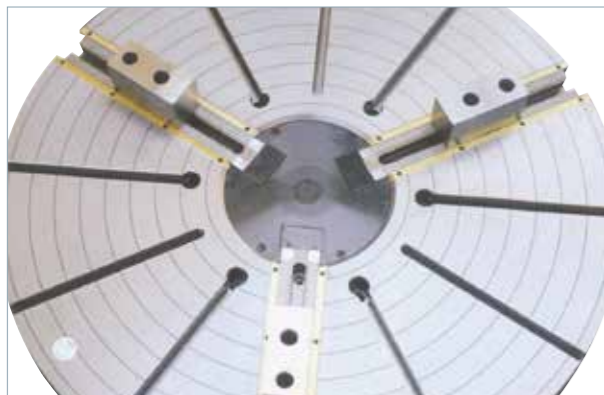

3 jaws, 4 jaws, 6 jaws hydraulic chucks are available as options to reduce valuable set up time.



Machine monitoring system

STANDARD ACCESSORIES

- Hydrostatic working table
- Siemens 840D sl controller
- ZF dual speed gearbox
- 8 jaws independent manual chuck
- Hydraulic unit
- Coolant unit
- Pressure relief automatic lubrication system
- Spindle oil chiller
- X & Z- axis linear scales
- Air conditioner for electrical cabinet
- Chip conveyor and chip bucket
- Working lamp
- Signal tower light (3 stage)
- Tool box with tools
- Operation manual
- Square guarding
- 16 positions tool magazine

OPTIONAL ACCESSORIES

- |                           |                                  |   |
|---------------------------|----------------------------------|---|
| ■ FANUC 31i controller    | ■ Door interlock                 | ■ Coolant chiller                             |
| ■ Magnetic chuck          | ■ Z-axis travel extended         | ■ Tool magazine for 24,32,48,60 tool position |
| ■ Hydraulic chuck         | ■ Grinding attachment            | ■ ATC series turning tool holder              |
| ■ Tool presetter          | ■ Coolant through spindle system | ■ ATC+C series turning tool holder            |
| ■ Work-piece probe        | ■ Paper filter                   | ■ ATC+C live tools                            |
| ■ Full enclosure guarding | ■ Transformer                    |   |
| ■ Pendant control         | ■ Oil skimmer                    |   |



Tool presetter



Oil skimmer



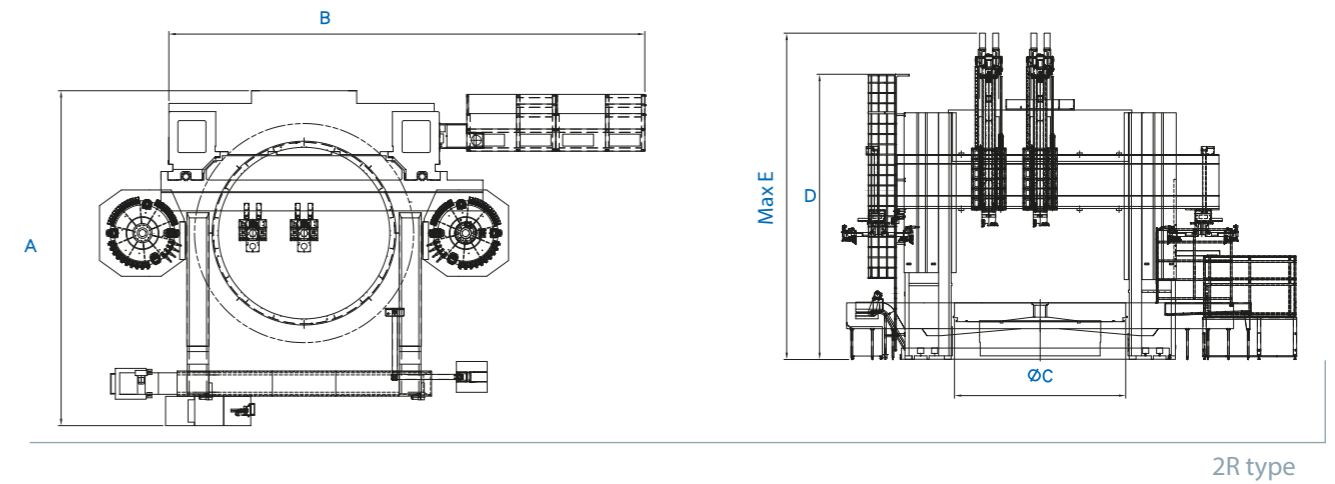
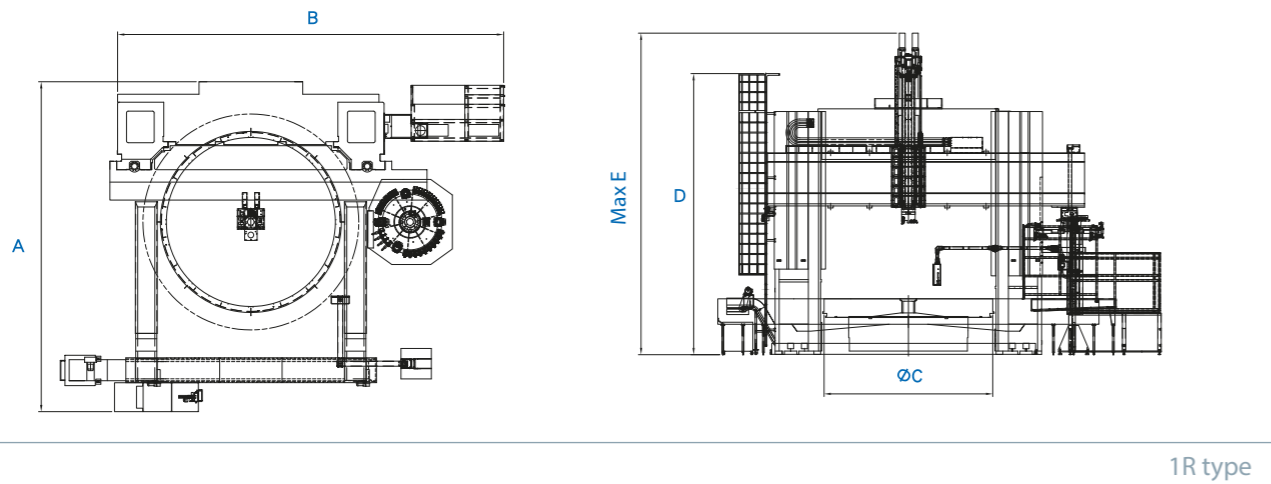

1R Type

	A	B	C	D	E
VTH3000ATC	8500	13000	3000	5715	7400
VTH3000ATC - I	8500	13000	3000	6315	8000
VTH3000ATC - II	8500	13000	3000	6915	8600
VTH3000ATC - III	8500	13000	3000	7525	9000
VTH3500ATC	9600	14500	3500	5715	7400
VTH3500ATC - I	9600	14500	3500	6315	8000
VTH3500ATC - II	9600	14500	3500	6915	8600
VTH3500ATC - III	9600	14500	3500	7525	9000
VTH4000ATC	9600	14500	4000	5715	7400
VTH4000ATC - I	9600	14500	4000	6315	8000
VTH4000ATC - II	9600	14500	4000	6915	8600
VTH4000ATC - III	9600	14500	4000	7525	9000
VTH4500ATC	10000	15000	4500	5715	7400
VTH4500ATC - I	10000	15000	4500	6315	8000
VTH4500ATC - II	10000	15000	4500	6915	8600
VTH4500ATC - III	10000	15000	4500	7525	9000
VTH5000ATC	11500	18000	5000	8330	9700
VTH5000ATC - I	11500	18000	5000	8330	10300
VTH5000ATC - II	11500	18000	5000	8330	10700
VTH5000ATC - III	11500	18000	5000	9230	11100
VTH6000ATC	12500	18000	6000	8330	9700
VTH6000ATC - I	12500	18000	6000	8330	10300
VTH6000ATC - II	12500	18000	6000	8330	10700
VTH6000ATC - III	12500	18000	6000	9230	11100
VTH7000ATC	15000	21000	7000	9645	10400
VTH7000ATC - I	15000	21000	7000	9645	11200
VTH7000ATC - II	15000	21000	7000	9645	11600
VTH7000ATC - III	15000	21000	7000	10775	13300
VTH8000ATC	15000	21000	8000	9645	10400
VTH8000ATC - I	15000	21000	8000	9645	11200
VTH8000ATC - II	15000	21000	8000	9645	11600
VTH8000ATC - III	15000	21000	8000	10775	13300

2R Type

	A	B	C	D	E
VTH3000ATC - 2R	8500	13000	3000	5715	7400
VTH3000ATC - I - 2R	8500	13000	3000	6315	8000
VTH3000ATC - II - 2R	8500	13000	3000	6915	8600
VTH3000ATC - III - 2R	8500	13000	3000	7525	9000
VTH3500ATC - 2R	9600	14500	3500	5715	7400
VTH3500ATC - I - 2R	9600	14500	3500	6315	8000
VTH3500ATC - II - 2R	9600	14500	3500	6915	8400
VTH3500ATC - III - 2R	9600	14500	3500	7525	9000
VTH4000ATC - 2R	9600	14500	4000	5715	7400
VTH4000ATC - I - 2R	9600	14500	4000	6315	8000
VTH4000ATC - II - 2R	9600	14500	4000	6915	8600
VTH4000ATC - III - 2R	9600	14500	4000	7525	9000
VTH4500ATC - 2R	10000	15000	4500	5715	7400
VTH4500ATC - I - 2R	10000	15000	4500	6315	8000
VTH4500ATC - II - 2R	10000	15000	4500	6915	8600
VTH4500ATC - III - 2R	10000	15000	4500	7525	9000
VTH5000ATC - 2R	11500	20500	5000	8330	9700
VTH5000ATC - I - 2R	11500	20500	5000	8330	10300
VTH5000ATC - II - 2R	11500	20500	5000	8330	10700
VTH5000ATC - III - 2R	11500	20500	5000	9230	11100
VTH6000ATC - 2R	12500	20500	6000	8330	9700
VTH6000ATC - I - 2R	12500	20500	6000	8330	10300
VTH6000ATC - II - 2R	12500	20500	6000	8330	10700
VTH6000ATC - III - 2R	12500	20500	6000	9230	11100
VTH7000ATC - 2R	15000	23000	7000	9645	10400
VTH7000ATC - I - 2R	15000	23000	7000	9645	11200
VTH7000ATC - II - 2R	15000	23000	7000	9645	11600
VTH7000ATC - III - 2R	15000	23000	7000	10775	13300
VTH8000ATC - 2R	15000	23000	8000	9645	10400
VTH8000ATC - I - 2R	15000	23000	8000	9645	11200
VTH8000ATC - II - 2R	15000	23000	8000	9645	11600
VTH8000ATC - III - 2R	15000	23000	8000	10775	13300

Dimension of Tool Holder

ATC series

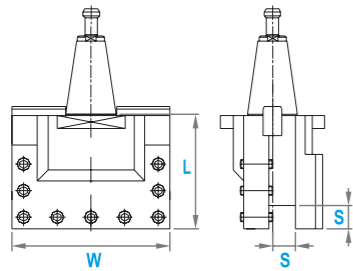

Model	W	L	S	Model	W	L	S
BT50-STST16032	220	160	32	BT50-DTST16032	220	160	32
BT50-STST16040	220	160	40	BT50-DTST16040	220	160	40
BT50-STMT16032	250	160	32	BT50-DTMT16032	250	160	32
BT50-STMT16040	250	160	40	BT50-DTMT16040	250	160	40
BT60-STST19032	290	190	32	BT60-DTST19732	290	197	32
BT60-STST19040	290	190	40	BT60-DTST19740	290	197	40

ATC+C series (Turning tool holder)

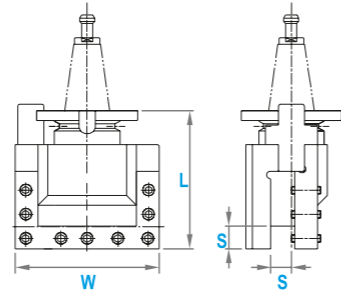

Model	W	L	S	Model	W	L	S
BT50-SMST19732	220	197	32	BT50-DMST21032	220	210	32
BT50-SMST19740	220	197	40	BT50-DMST21040	220	210	40
BT50-SMMT19732	250	197	32	BT50-DMMT21032	250	210	32
BT50-SMMT19740	250	197	40	BT50-DMMT21040	250	210	40
BT60-SMST25032	290	250	32	BT60-DMST25032	290	250	32
BT60-SMST25040	290	250	40	BT60-DMST25040	290	250	40

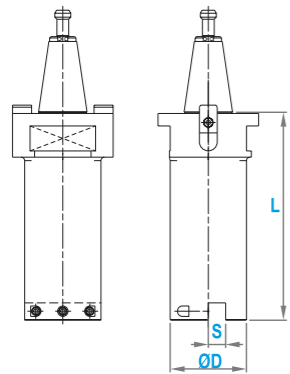

Model	L	S	D	Model	L	S	D
BT50-STBB20025	200	25	100	BT50-DTBB20025	200	25	100
BT50-STBB30025	300	25	110	BT50-DTBB30025	300	25	110
BT60-STBB20025	200	25	140	BT60-DTBB20025	200	25	140
BT60-STBB30025	300	25	140	BT60-DTBB30025	300	25	140

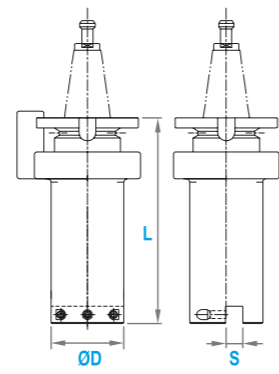

Model	L	S	D	Model	L	S	D
BT50-SMBB20025	200	25	100	BT50-DMBB20025	200	25	100
BT50-SMBB30025	300	25	110	BT50-DMBB30025	300	25	110
BT60-SMBB20025	200	25	140	BT60-DMBB20025	200	25	140
BT60-SMBB30025	300	25	140	BT60-DMBB30025	300	25	140

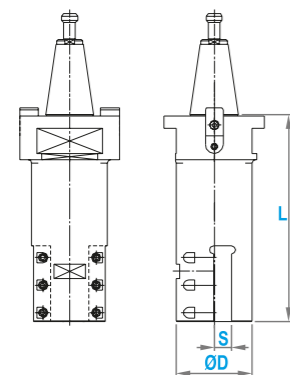

Model	L	S	D	Model	L	S	D
BT50-STBT20025	200	25	100	BT50-DTBT20025	200	25	100
BT50-STBT30025	300	25	110	BT50-DTBT30025	300	25	110
BT60-STBT20025	200	25	140	BT60-DTBT20025	200	25	140
BT60-STBT30025	300	25	140	BT60-DTBT30025	300	25	140

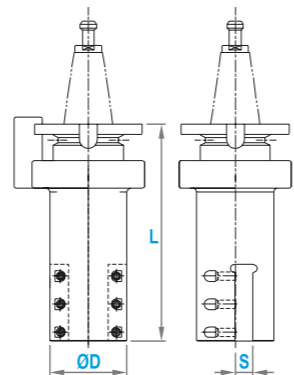

Model	L	S	D	Model	L	S	D
BT50-SMBT20025	200	25	100	BT50-DMBT20025	200	25	100
BT50-SMBT30025	300	25	110	BT50-DMBT30025	300	25	110
BT60-SMBT20025	200	25	140	BT60-DMBT20025	200	25	140
BT60-SMBT30025	300	25	140	BT60-DMBT30025	300	25	140



BT-50

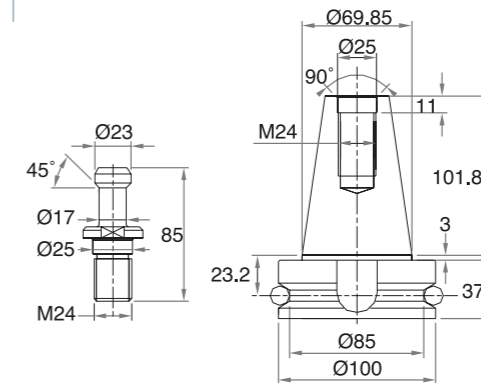

BT-60

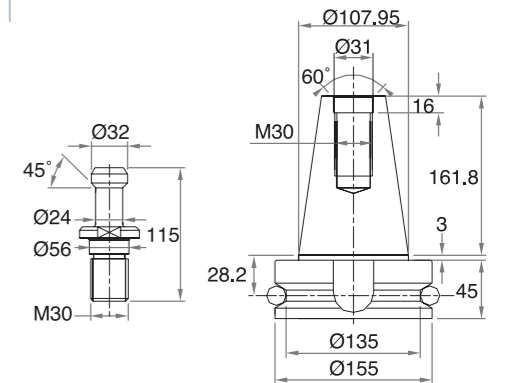

ATC+C series (Live tool holder)

Side lock chuck

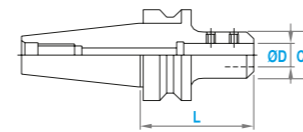

Model	L	C	D
BT50-SLA20-105	105	50	20
BT50-SLA25-105	105	55	25
BT50-SLA32-105	105	60	32
BT50-SLA40-105	105	80	40
BT50-SLA50.8-105	105	95	50.8
BT60-SLA20-105	105	50	20
BT60-SLA25-105	105	55	25
BT60-SLA32-105	105	60	32
BT60-SLA40-105	105	80	40
BT60-SLA50.8-105	105	95	50.8

Facemill holder (Milling cutter excluded)

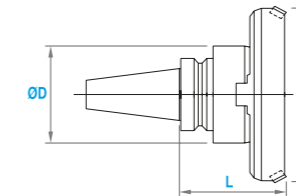

Model	L	C	D
BT50-FMA25.4-105	155	80	60
BT50-FMA31.75-105	160	100	70
BT50-FMA38.1-75	130	125	85
BT50-FMA50.8-75	135	150	95
BT60-FMA25.4-105	155	80	60
BT60-FMA31.75-105	160	100	70
BT60-FMA38.1-75	130	125	85
BT60-FMA50.8-75	135	150	95

Collet chuck

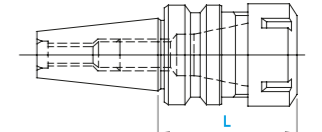

Model	L	Clamping range	Collet type
BT50-ER20-100	100	1-13	ER-20
BT50-ER32-100	100	3-20	ER-32
BT50-ER40-100	100	4-26	ER-40
BT60-ER20-100	100	1-13	ER-20
BT60-ER32-100	100	3-20	ER-32
BT60-ER40-100	100	4-26	ER-40

Tap holder

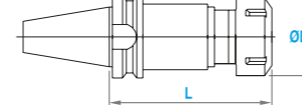

Model	L	D	Tapping range
BT50-TER16	80	28	M4-M10
BT50-TER40	117	63	M6-M27
BT60-TER16	83	28	M4-M10
BT60-TER40	126	63	M6-M27

Boring bar (Rough boring)

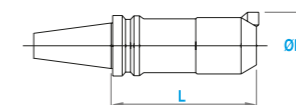

Model	L	D
BT50-BSB62-300	300	62~90
BT50-BSB72-285	285	72~110
BT50-BSB105-285	285	105~160
BT60-BSB62-300	300	62~90
BT60-BSB72-285	285	72~100
BT60-BSB105-285	285	105~160

VTH5000 ~ VTH8000 series

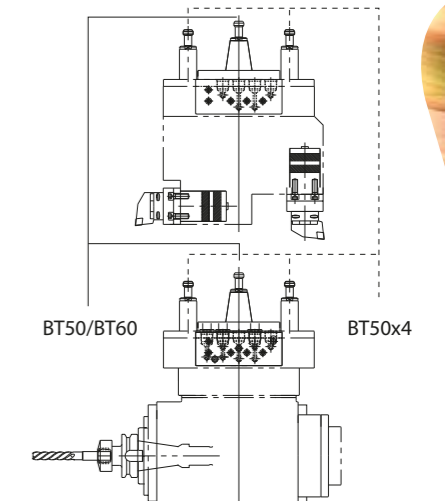

※Tool holders on VTH5000 and above Model are special specifications, please contact You Ji for details information.



Standard Specification		Unit	VTH3000ATC	VTH3000ATC+C	VTH3000ATC-2R	VTH3000ATC+C-2R	VTH3500ATC	VTH3500ATC+C	VTH3500ATC-2R	VTH3500ATC+C-2R	VTH4000ATC	VTH4000ATC+C	VTH4000ATC-2R	VTH4000ATC+C-2R	VTH4500ATC	VTH4500ATC+C	VTH4500ATC-2R	VTH4500ATC+C-2R								
<b>Capacity</b>																										
Table diameter	mm		Ø3000				Ø3500				Ø4000				Ø4500											
Max. swing diameter	mm		Ø3400				Ø4100				Ø4600				Ø5100											
Max. turning diameter	mm		Ø3300				Ø3800				Ø4300				Ø4800											
Max. turning height	mm		1700 ; I : 2100 ; II : 2700 ; III : 3100				1700 ; I : 2100 ; II : 2700 ; III : 3100				1600 ; I : 2000 ; II : 2600 ; III : 3000				1600 ; I : 2000 ; II : 2600 ; III : 3000											
Max. work-piece weight	ton		45				45				60				60											
<b>Travel</b>																										
X-axis travel	mm		-1500,1650		X2: -700,-1650 / X1:-50,1650				-2000,2350		X2: -700,-2350 / X1: -50,2350				-2000,2350		X2: -700,-2350 / X1: -50,2350				-2000,2650		X2: -700,-2650 / X1: -50,2650			
Z-axis travel	mm		1500 ; I : 1500 ; II : 1500 ; III : 1500				1500 ; I : 1500 ; II : 1500 ; III : 1500				1500 ; I : 1500 ; II : 1500 ; III : 1500				1500 ; I : 1500 ; II : 1500 ; III : 1500											
Cross rail travel	mm		1200 ; I : 1400 ; II : 2000 ; III : 2400				1200 ; I : 1400 ; II : 2000 ; III : 2400				1200 ; I : 1400 ; II : 2000 ; III : 2400				1200 ; I : 1400 ; II : 2000 ; III : 2400											
<b>Spindle (Siemens motor)</b>																										
spindle speed	Low	min <sup>-1</sup>	1~40				1~40				1~14				1~14											
	High	min <sup>-1</sup>	40~75				40~75				14~60				14~60											
Live spindle speed	Low	min <sup>-1</sup>	1~1200		1~1200		1~1200		1~1200		1~1200		1~1200		1~1200		1~1200		1~1200							
	High	min <sup>-1</sup>	1200~2400		1200~2400		1200~2400		1200~2400		1200~2400		1200~2400		1200~2400		1200~2400		1200~2400							
Max. table torque	N·m(kgf·m)		62694(6397)	88667(9048)	112849(11515)		62694(6397)	88667(9048)	112849 (11515)		216485(22090)	220444(22494)	389673(39762)		216485(22090)	220444(22494)	389673(39762)									
<b>Feed rate</b>																										
X-axis rapid traverse	m/min		6				6				6				6											
Z-axis rapid traverse	m/min		10				10				10				10											
Cutting feed rate	mm/min		1~2000				1~2000				1~2000				1~2000											
Manual feed rate	m/min		0~6				0~6				0~6				0~6											
<b>Automation Tool Changer (ATC)</b>																										
Number of tool position			16		16+16				16		16+16				16		16+16									
Type of tool shank			7/24 Taper BT-50 (BT-60)				7/24 Taper BT-50 (BT-60)				7/24 Taper BT-50 (BT-60)				7/24 Taper BT-50 (BT-60)											
Max. tool length of ATC	mm		400				400				400				400											
Max. tool weight	kg		80(50)				80(50)				80(50)				80(50)											
Max. loading weight of ATC	kg		1200(800)				1200(800)				1200(800)				1200(800)											
Time of tool change(tool to tool)	sec		60				60				60				60											
<b>Controller</b>																										
SIEMENS SINUMERIK 840D sl																										
<b>Siemens motor</b>																										
Spindle motor	kW		60/84(1PH7186)	40/66(1PH7184)x2	60/84(1PH7186)x2	60/84(1PH7186)x2	60/84(1PH7186)	40/66(1PH7184)x2	60/84(1PH7186)x2	60/84(1PH7186)x2	100/140(1PH7224)	40/66(1PH7184)x2	100/140(1PH7224)x2	100/140(1PH7224)x2	100/140(1PH7224)	40/66(1PH7184)x2	100/140(1PH7224)x2	100/140(1PH7224)x2	100/140(1PH7224)x2							
Live spindle motor	kW		11/15(1PH7131)		11/15(1PH7131)		11/15(1PH7131)		11/15(1PH7131)		17/22.5(1PH7137)		17/22.5(1PH7137)		17/22.5(1PH7137)		17/22.5(1PH7137)		17/22.5(1PH7137)							
X axis servo motor	kW		7.7(1FK7105)		7.7(1FK7105)x2		7.7(1FK7105)		7.7(1FK7105)x2		7.7(1FK7105)		7.7(1FK7105)x2		7.7(1FK7105)		7.7(1FK7105)x2		7.7(1FK7105)x2							
Z axis servo motor	kW		7.7(1FK7105)		7.7(1FK7105)x2		7.7(1FK7105)		7.7(1FK7105)x2		7.7(1FK7105)		7.7(1FK7105)x2		7.7(1FK7105)		7.7(1FK7105)x2		7.7(1FK7105)x2							
Coolant pump	kW		3	3	3	3	3	3	3	3	3	3	3	3	3	3	3	3	3							
Power capacity	KVA		130	150	245	260	130	150	245	260	130	160	290	310	130	160	290	310								
<b>Tank capacity</b>																										
Hydraulic tank	L		200		200+100				200		200 +100				200		200+100									
Coolant tank	L		2000	2000	2000	2000	2000	2000	2000	2000	2500	2500	2500	2500	2800	2800	2800	2800								
Lubrication tank	L		4.6+8	4.6+8	4.6+8	4.6+8	4.6+8	4.6+8	4.6+8	4.6+8	4.6+8	4.6+8	4.6+8	4.6+8	4.6+8	4.6+8	4.6+8	4.6+8								
<b>Machine dimension</b>																										
Floor dimension	mm		13000x8500		13000x8500				14500x9600		14500 x9600				14500x9600		14500x9600				15000x10000		15000x10000			
Machine height	mm		7400 ; I : 8000 ; II : 8600 ; III : 9000				7400 ; I : 8000 ; II : 8600 ; III : 9000				7400 ; I : 8000 ; II : 8600 ; III : 9000				7400 ; I : 8000 ; II : 8600 ; III : 9000											
Machine weight	ton		70	75	80	85	90	95	100	105	100	105	110	115	125	130	135	140								

※ Specification is subject to change without prior notice.

Standard Specification		Unit	VTH5000ATC	VTH5000ATC+C	VTH5000ATC-2R	VTH5000ATC+C-2R	VTH6000ATC	VTH6000ATC+C	VTH6000ATC-2R	VTH6000ATC+C-2R	VTH7000ATC	VTH7000ATC+C	VTH7000ATC-2R	VTH7000ATC+C-2R	VTH8000ATC	VTH8000ATC+C	VTH8000ATC-2R	VTH8000ATC+C-2R	
<b>Capacity</b>																			
Table diameter	mm		Ø5000				Ø6000				Ø7000				Ø8000				
Max. swing diameter	mm		Ø6400				Ø7400				Ø9000				Ø9000				
Max. turning diameter	mm		Ø5900				Ø6900				Ø8500				Ø8900				
Max. turning height	mm		2100 ; I :2700 ; II :3100 ; III:3500				2100 ; I :2700 ; II :3100 ; III:3500				2600 ; I :3400 ; II :3800 ; III:5000				2600 ; I :3400 ; II :3800 ; III:5000				
Max. work-piece weight	ton		100				150				250				300				
<b>Travel</b>																			
X-axis travel	mm		-2350,3010		X2: 250,-3010 / X1: -250,3010		-3000,3510		X2: 250,-3510 / X1: -250,3510		-4300,5050		X2: 250,-5050 / X1:-250,5050		-4300,5050		X2: 250,-5050 / X1:-250,5050		
Z-axis travel	mm		1500 ; I :1500 ; II :2000 ; III:2000				1500 ; I :1500 ; II :2000 ; III:2000				1500 ; I :2000 ; II :2000 ; III:2500				1500 ; I :2000 ; II :2000 ; III:2500				
Cross rail travel	mm		1400 ; I :2000 ; II :2400 ; III:2800				1400 ; I :2000 ; II :2400 ; III:2800				1600 ; I :2400 ; II :2800 ; III:4000				1600 ; I :2400 ; II :2800 ; III:4000				
<b>Spindle (Siemens motor)</b>																			
spindle speed	Low	min <sup>-1</sup>	5~16				3~12				3~9				3~9				
	High	min <sup>-1</sup>	17~40				13~25				10~20				10~20				
Live spindle speed	Low	min <sup>-1</sup>	1~1200		1~1200		1~1200		1~1200		1~1200		1~1200		1~1200		1~1200		
	High	min <sup>-1</sup>	1200~2400		1200~2400		1200~2400		1200~2400		1200~2400		1200~2400		1200~2400		1200~2400		
Max. table torque	N·m(kgf·m)		281313(28705)		390712(39868)		356213(63648)		494741 (50483)		450982(46018)		626364(63914)		450982(46018)		626364(63914)		
<b>Feed rate</b>																			
X-axis rapid traverse	m/min		6				6				6				6				
Z-axis rapid traverse	m/min		10				10				10				10				
Cutting feed rate	mm/min		1~2000				1~2000				1~2000				1~2000				
Manual feed rate	m/min		0~6				0~6				0~6				0~6				
<b>Automation Tool Changer (ATC)</b>																			
Number of tool position			16		16+16		16		16+ 16		16		16+16		16		16+16		
Type of tool shank			BT-50 / BT-60 + (4xBT-50)				BT-50 / BT-60 + (4xBT-50)				BT-50 / BT-60 + (4xBT-50)				BT-50 / BT-60 + (4xBT-50)				
Max. tool length of ATC	mm		400				400				400				400				
Max. tool weight	kg		80(50)				80(50)				80(50)				80(50)				
Max. loading weight of ATC	kg		1200(800)				1200(800)				1200(800)				1200(800)				
Time of tool change(tool to tool)	sec		60				60				60				60				
<b>Controller</b>																			
SIEMENS SINUMERIK 840D sl																			
<b>Siemens motor</b>																			
Spindle motor	kW		60/84(1PH7186)x2		100/140(1PH7224)x2		60/84(1PH7186)x2		100/140 (1PH7224)x2		100/140(1PH7224)x2		100/140(1PH7224)x2		100/140(1PH7224)x2		100/140(1PH7224)x2		
Live spindle motor	kW		17/22.5(1PH7137)		17/22.5(1PH7137)		17/22.5(1PH7137)		17/22.5(1PH7137)		17/22.5(1PH7137)		17/22.5(1PH7137)		17/22.5(1PH7137)		17/22.5(1PH7137)		
X axis servo motor	kW		7.7(1FK7105)		7.7(1FK7105)x2		7.7(1FK7105)		7.7(1FK 7105)x2		7.7(1FK7105)		7.7(1FK7105)x2		7.7(1FK7105)		7.7(1FK7105)x2		
Z axis servo motor	kW		7.7(1FK7105)		7.7(1FK7105)x2		7.7(1FK7105)		7.7(1FK 7105)x2		7.7(1FK7105)		7.7(1FK7105)x2		7.7(1FK7105)		7.7(1FK7105)x2		
Coolant pump	kW		3	3	3	3	3	3	3	3	3	3	3	3	3	3	3	3	
Power capacity	KVA		165	185	290	310	165	185	290	310	165	185	290	310	165	185	290	310	
<b>Tank capacity</b>																			
Hydraulic tank	L		350		350+100		350		350+ 100		350		350+150		350		350+150		
Coolant tank	L		2000+750+750				2000+750+750				4000+1400+1400				4000+1400+1400				
Lubrication tank	L		4.6+8	4.6+8	4.6+8	4.6+8	4.6+8	4.6+8	4.6+8	4.6+8	4.6+8	4.6+8	4.6+8	4.6+8	4.6+8	4.6+8	4.6+8	4.6+8	
<b>Machine dimension</b>																			
Floor dimension	mm		18000x11500		20500x11500		18000x12500		20500x 12500		21000x15000		23000x15000		21000x15000		23000x15000		
Machine height	mm		9700 ; I :10300 ; II :10700 ; III:11100				9700 ; I :10300 ; II :10700 ; III:11100				10400 ; I :11200 ; II :11600 ; III:13300				10400 ; I :11200 ; II :11600 ; III:13300				
Machine weight	ton		200	205	230	235	280	285	310	315	400	405	430	435	420	425	450	455	

※ Specification is subject to change without prior notice.